

SANYO

INSTRUCTION MANUAL

Digital Camera

VPC-MZ3EX VPC-MZ3 VPC-MZ3GX

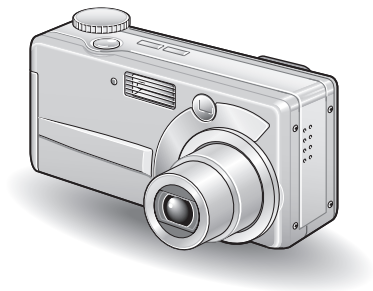

Important note

This manual explains how to safely operate the VPC-MZ3.

Please read these instructions carefully before using the digital camera. Make sure to read and understand the section "USING YOUR DIGITAL CAMERA SAFELY AND CORRECTLY" on pages 7 to 23. Keep this manual in a safe place for later reference.

A CompactFlash is not included with Model VPC-MZ3GX.

Warning

TO PREVENT THE RISK OF FIRE OR ELECTRIC SHOCK, DO NOT EXPOSE THIS APPLIANCE TO RAIN OR MOISTURE

FOR AMERICAN USERS

- This equipment has been tested and found to comply with the limits for a Class B digital device, pursuant to Part 15 of the FCC Rules. These limits are designed to provide reasonable protection against harmful interference in a residential installation. This equipment generates, uses and can radiate radio frequency energy and, if not installed and used in accordance with the instructions, may cause harmful interference to radio communications. However, there is no guarantee that interference will not occur in a particular installation. If this equipment does cause harmful interference to radio or television reception, which can be determined by turning the equipment off and on, the user is encouraged to try to correct the interference by one or more of the following measures:
 - Reorient or relocate the receiving antenna.
 - Increase the separation between the equipment and receiver.
 - Connect the equipment into an outlet on a circuit different from that to which the receiver is connected.
 - Consult the dealer or an experienced radio/TV technician for help.
- Changes or modifications not expressly approved by the party responsible for compliance could void the user's authority to operate the equipment.



Tested to Comply with FCC Standards

FOR HOME OR OFFICE USE

Declaration of Conformity

Model Number : VPC-MZ3
Trade Name : SANYO
Responsible party : SANYO FISHER COMPANY
Address : 21605 Plummer Street, Chatsworth, California 91311
Telephone No. : (818) 998-7322

This device complies with Part 15 of the FCC Rules. Operation is subject to the following two conditions:

- (1) this device may not cause harmful interference, and
- (2) this device must accept any interference received, including interference that may cause undesired operation.

FOR CANADIAN USERS

- This Class B digital apparatus complies with Canadian ICES-003.

OUTLINE OF OPERATION

To help you get started enjoying using your digital camera right away, given below is an outline of the fundamental operation, from setup to shooting to playback.

SETUP

- ➊ Charge the battery pack (see pages 27 and 33).
- ➋ Install the battery pack (see page 28).
- ➌ Install the CompactFlash^{*1} (see page 28).
- ➍ Format the CompactFlash (see page 35).

NOTE

- This camera uses a CompactFlash memory card instead of photographic film to record images. Be sure to install the CompactFlash before operating the camera. A 16MB CompactFlash is supplied with this camera^{*1}. A 32MB CompactFlash is also available as a separately sold accessory.



SHOOTING

- ➎ Take photos in the BASIC operation mode^{*2}.
 - See “Shooting in the BASIC mode” on page 42.
 - See “BASIC MODE” on page 77.



PLAYBACK

- 1 Set the playback mode (see page 85).
- 2 Play back the images.
 - See “PLAYING BACK STILL IMAGES” on page 87.
 - See “PLAYING BACK SEQUENTIAL SHOTS” on page 89.
 - See “PLAYING BACK VIDEO CLIPS” on page 90.



*1: About the CompactFlash

This digital camera can use both CompactFlash and Microdrive cards for data storage. This manual is written with the premise that CompactFlash cards are used. In this manual, CompactFlash and Microdrive cards are both referred to as “card”.

A CompactFlash is not included with Model VPC-MZ3GX.

*2: Shooting in the BASIC mode

In the BASIC mode, the Scene Select function—whereby simply by selecting one from a short list of shooting conditions, the suitable settings are automatically completed—is available. Also, only the necessary shooting settings are displayed, making it easy even for the novice photographer to enjoy using this digital camera.

Symbols used in this manual

- | | |
|----------------------|---|
| HINT | Points that may prove useful when using the digital camera. |
| NOTE | Points giving some extended instructions or special points to pay attention to. |
| CAUTION | Points that require special attention |
| (see page xx) | Refer to the page indicated for detailed information. |

CONTENTS

OUTLINE OF OPERATION	1
USING YOUR DIGITAL CAMERA SAFELY AND CORRECTLY	7
CAUTIONS CONCERNING HIGH TEMPERATURES	24
CHECKING THE INCLUDED ACCESSORIES	25
QUICK START FOR CAPTURING IMAGES	27

■ PREPARATION

PARTS NAMES	31
RECHARGING THE BATTERY PACK	33
FORMATTING A CARD	35
TURNING THE POWER ON/OFF	37
SETTING SCREENS AND OPTION SETTING SCREENS	39

■ CAPTURING IMAGES AND RECORDING SOUNDS

BEFORE TAKING PICTURES	55
SHOOTING/RECORDING MODE SETTINGS	59
CAPTURING STILL IMAGES	60
SEQUENTIAL SHOTS	61
VIDEO CLIPS	69
AUDIO RECORDINGS	70
BASIC SHOOTING FUNCTIONS	72
BASIC MODE	77

■ **PLAYBACK**

PLAYBACK MODE SETTINGS	85
PLAYING BACK STILL IMAGES	87
PLAYING BACK SEQUENTIAL SHOTS	89
PLAYING BACK VIDEO CLIPS	90
LISTENING TO AUDIO RECORDINGS	93
USING THE VARIOUS PLAYBACK FUNCTIONS	95
DISPLAYING IMAGE INFORMATION (PLAYBACK INFO SCREEN).	101

■ **EXPERT MODE**

WIDE-RANGE SHOT	103
ADDING A VOICE MEMO	104
SETTING THE FOCUS MODE	105
LIGHT-MEASURING MODE SETTING	106
WHITE BALANCE SETTING	107
ISO SENSITIVITY SETTING	109
SETTING THE EXPOSURE CONTROL	110
ADJUSTING THE COLOR TONES (REAL-COLOR EQUALIZER).	113
DIGITAL ZOOM SETTING	122
QUICK SHOT SETTING (STILL IMAGE SHOOTING MODE ONLY)	123
EXPOSURE CORRECTION	124
FLICKER-REDUCTION SETTING (VIDEO CLIP SHOOTING ONLY)	125
SHOOTING SETTING INFORMATION DISPLAY (SHOOTING INFO SCREEN).	126

CONTENTS

■ OTHER FUNCTIONS

COPYING IMAGES	128
CHANGING IMAGE SIZE	129
ADDING TEXT	131
ADDING A VOICE MEMO	135
COMBINING IMAGES (ADD PHOTO FUNCTION)	137
EDITING VIDEO CLIPS	143
PRINT SETTINGS	151
IMAGE PROTECT MODE (PREVENTING ACCIDENTAL ERASURE)	159
ERASING DATA	161
IMAGE AND AUDIO DATA STORAGE	164
USING THE CAMERA WITH A COMPUTER	166

■ CAMERA SETTINGS AND DISPLAYS

SETTING THE DATE AND TIME	168
SETTING THE OPERATIONAL SOUNDS	172
HELP FUNCTION	175
DISPLAY LANGUAGE.....	176
POWER SAVE MODE.....	177
SETTING THE TV SYSTEM	179
ASSIGNING FILE NAMES.....	180
CHECKING THE REMAINING BATTERY PACK CHARGE.....	182
CHECKING THE REMAINING CARD MEMORY	184

■ APPENDICES

TROUBLESHOOTING.....	187
SPECIFICATIONS.....	205

USING YOUR DIGITAL CAMERA SAFELY AND CORRECTLY

CONCERNING THE DIGITAL CAMERA

WARNING

- If the digital camera makes a strange noise, emits a strange odor, or if smoke comes out from it, immediately turn off the power and remove the battery pack.

- If the digital camera is used under these conditions, it may cause a fire or electric shock. Immediately turn off the digital camera, remove the battery pack, and wait to make sure no more smoke comes from the digital camera. Then take it to the dealer for service. Do not try to repair or open the digital camera yourself.



- **Do not modify or open the cabinet**

- High voltage circuits are inside, and there is a high risk of fire or electric shock if they are touched. Any internal check, setting, or repair should be performed by the dealer.



- **Do not use while driving**

- Do not capture images, play back images, or watch the LCD monitor while driving a vehicle. Doing so may cause an accident.
- Be careful where you put down the digital camera inside an automobile. During sudden stops or turns it may fall behind the brake pedal and prevent braking.
- When using the digital camera while walking, be very careful of your surroundings and especially the traffic to avoid accidents.



- **Be aware of your surroundings when using the digital camera**

- Pay close attention to your surroundings when using the digital camera. Failure to do so may lead to an accident or injury.
- Do not use the digital camera inside an airplane or elsewhere where its use may be restricted.



■ Do not get the digital camera wet

- This digital camera is not water-resistant. Do not allow it to get wet, as doing so may cause a fire or electric shock.
- Do not use the digital camera in a bathroom
- If the digital camera gets wet, immediately turn it off and remove the battery pack. Then take it to a dealer for repair. Using the digital camera after it has become wet may cause a fire, electric shock, or other accident.



■ Do not use during a storm

- To avoid the risk of being struck by lightning, do not use the digital camera during a thunderstorm. In particular, if used in an open field, you have an increased chance of being struck by lightning. Quickly seek refuge in a place that will protect you from lightning.



■ Do not place on an unstable surface

- The digital camera may fall, resulting in damage to the digital camera or injury.
- If the digital camera has fallen and its body is damaged, turn it off, remove the battery pack, and take it to the dealer for repair. Using the digital camera after its body has been damaged may cause a fire or electric shock.



■ Do not look through the digital camera into the sun

- Do not look through the digital camera at the sun or any other strong source of light. Doing so may seriously injure your eyes.



■ Do not use the flash close to a person's face

- To prevent possible eye injury, do not use the flash near a person's face (especially young children or babies). If the flash is used close to a person's opened eyes, there is a risk that it may damage that person's eyesight.



USING YOUR DIGITAL CAMERA SAFELY AND CORRECTLY

(CONCERNING THE DIGITAL CAMERA)

WARNING

■ Do not use where there is risk of explosion

- Do not use the digital camera in a location where there is explosive gas, or any other flammable material in the air. Doing so may cause a fire or an explosion.



■ Keep the digital camera out of the reach of children

- The following may happen if children play with the digital camera:
 - They may wrap the strap around their neck and suffocate.
 - They may swallow the battery pack or other small parts. In such a case, consult a physician immediately.
 - They may damage their eyesight if the flash goes off too close to their eyes.
 - They may get hurt by the digital camera.



CAUTION

■ Cautions when carrying the digital camera

- Do not walk around holding the digital camera by the handstrap. It may hit other objects and get damaged. When walking around, hold the digital camera in your hand or place it in a pocket.
- Be careful not to drop the digital camera or subject it to strong shocks.
- Make sure direct sunlight does not hit the digital camera lens, as that may damage the internal parts. When not using the digital camera, be sure to always turn it off and retract the lens.



■ If the digital camera is not going to be used for a long period of time

- For safety's sake, remove the battery pack from the camera. This will prevent any possible excess heat or leakage of battery fluid that may result in injuries or damage to nearby objects. (Note that when the battery pack is removed for a long period, the time and date settings will be cleared.)



■ Cautions during use and storage

- This digital camera is a precision instrument. When using or storing the digital camera, make sure to avoid the following locations to avoid damage.
 - Places in direct sunlight
 - Places where humidity and temperature are high
 - Places that may get wet
 - Places close to an air conditioner or heater
 - Inside a car
 - Places where there is dust and dirt
 - Places where there is a fire burning
 - Places where volatile products are stored
 - Places subject to vibration



Operating environment

- | | |
|---------------|--|
| ● Temperature | 0 to 40°C (operation)
-20 to 60°C (storage) |
| ● Humidity | 30 to 90% (operation, no condensation)
10 to 90% (storage, no condensation) |

USING YOUR DIGITAL CAMERA SAFELY AND CORRECTLY

Concerning the supplied battery pack charger (Model VAR-L10)

DANGER

- **Risk of electric shock. Dry location use only.**
- **Do not recharge battery packs that are not Lithium-ion battery packs (Model DB-L10)**

- Do not use the supplied battery pack charger to recharge a battery pack other than the supplied Lithium-ion battery pack (DB-L10). Recharging a dry-cell battery or other type of rechargeable battery may cause excess heat, combustion, or leakage, and cause a fire, injuries, burns, or damage to nearby objects.



- **Use a 100 to 240 V AC power supply**

- If used with a power supply other than the one specified, it may cause a fire or electric shock.



- **Do not disassemble or modify the battery pack charger**

- It is dangerous to touch the inside of the battery pack charger. Doing so may cause a fire or electric shock.
- Do not use the battery pack charger as a direct current generator.



- **Do not get the battery pack charger wet**

- Make sure the battery pack charger does not get wet, as doing so may cause a fire or electric shock.
- Do not use the battery pack charger in a bathroom.
- If the battery pack charger gets wet, immediately unplug it from the power outlet and remove the battery pack. Then contact the place of purchase. If used while wet, it may cause a fire, electric shock, or an accident.



■ Cautions when plugging in the battery pack charger

- Securely plug the power cord all the way into the power outlet when using the battery pack charger. If the battery pack charger is used with the power cord not fully plugged in, heat may be generated and cause a fire.
- If the power cord is damaged, or cannot be correctly plugged into the power outlet, do not use the battery pack charger. Using the battery pack charger in this condition may cause a fire or electric shock.
- Do not allow dust, etc., to build up on the power cord or power outlet. A build-up of dust may cause a short circuit or generate heat and cause a fire.
- When unplugging the power cord, be sure to hold the power plug and slowly pull it out of the power outlet. Pulling the cord portion may damage the power cord and cause a fire or electric shock.



■ Do not pull on the power cord to unplug it

- Do not leave the power cord plugged into the power outlet while the other end is not plugged into the battery pack charger. The loose end can cause electrocution if touched with wet hands or if handled by children.
- Use only the power cord supplied with the battery pack charger. If a different power cord is used, it may be rated for a different current load, and that may cause a fire.
- The supplied power cord is for exclusive use with the supplied battery pack charger. Do not use it with other devices, as doing so may cause a fire or electric shock.
- Do not use a bundled power cord, as the heat generated may cause a fire.
- When using an extension cord, make sure that the total wattage of the connected devices does not exceed the rated value of the extension cord. If the power load exceeds the rated value, it may cause a fire.



USING YOUR DIGITAL CAMERA SAFELY AND CORRECTLY

Concerning the supplied battery pack charger (Model VAR-L10) (continued)

DANGER

■ Keep the battery pack charger out of the reach of children

- Children may place the battery pack or other small components in their mouth or perform some other such unforeseeable action. If swallowed, consult a physician immediately.



■ If smoke or a strange odor is emitted, or if strange noises are heard, immediately unplug the power cord from the power outlet

- If the battery pack charger is used under these conditions, it may cause a fire or electric shock.
- If strange conditions such as these occur, immediately unplug the battery pack charger, remove the battery pack, and wait to make sure no more smoke is emitted. Then contact the place of purchase. Do not try to repair or open the battery pack charger yourself.



■ Do not handle with wet hands

- Handling the battery pack charger with wet hands may cause an electric shock.



■ Do not use during a storm

- Do not touch the battery pack charger or power cord while it is plugged into a power outlet during a thunderstorm. Doing so may cause an electric shock.



■ Unplug the power cord from the power outlet when finished

- If the battery pack charger is left plugged into the power outlet for a long period of time, there is a risk of fire.



CAUTION

■ Do not damage the power cord

- Do not place heavy objects on the power cord. Do not place the power cord near a heat source. Do not excessively bend the power cord, modify it, or secure it with staples. Doing so may damage the power cord and cause a fire or electric shock.
- If the power cord is damaged, or if it does not plug properly into the battery pack charger or wall outlet, contact the place of purchase.



■ Do not place on an unstable surface

- The battery pack charger may fall, causing injury or damage.
- If the battery pack charger falls and the charger body is damaged, remove the battery pack and contact the place of purchase. If used while damaged, it may cause a fire, electric shock, or other damages.



■ Operating and storage conditions

- Do not use close to a heat source (close to a stove or heater) or leave it exposed to direct sunlight.



Operating environment

- Temperature 0 to 40°C (charging)
 -20 to 60°C (storage)
- Humidity 10 to 85% (charging and storage)

USING YOUR DIGITAL CAMERA SAFELY AND CORRECTLY

Concerning the Lithium-ion battery pack (Model DB-L10)

DANGER

This camera uses a Lithium-ion battery pack (Model DB-L10).

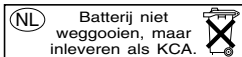

■ **If there is leaking, discoloration, change of shape, rise in temperature, damaged exterior, strange odor or any other abnormal condition, immediately discontinue use and remove the battery pack from the camera, taking care to keep it well away from fire.**

- Continued use of the battery pack under any of these conditions may result in fire, injury, explosion or other serious damage.
- If battery fluid is leaking, placing the battery pack in close proximity to a fire or other heat source may ignite the battery fluid and result in fire, damage, eruption of battery fluid, or smoke fumes.



■ **Do not transform, take apart, or modify.**

- Safety mechanisms and protective devices have been incorporated in the battery pack for the purpose of preventing danger. Any modification, by transforming, disassembling, or directly soldering to it, etc., will defeat these safety devices and possibly cause the battery pack to catch fire, explode, or leak or spew battery fluid.



■ **Do not connect the (+) and (-) terminals with a wire or other metal implement. Do not carry loose or keep with necklaces, hairpins, etc.**

- Doing so may result in a short circuit, high voltage flow, fire, explosion, leaking or spewing battery fluid, or heat generation. Metal such as a wire or necklace, etc. may cause heat to be generated.



■ **Do not throw the battery pack in the fire or subject it to heat**

- Doing so may cause the insulation to melt, damage the gas discharge valve and safety mechanisms, or ignite the battery fluid, resulting in fire or explosion.



■ Do not drop, hit, or submit the battery pack to strong shocks

- If the safety mechanisms and protective devices are broken, an abnormal chemical reaction may occur inside the battery pack, or cause the battery pack to catch fire, explode, leak or spew battery fluid, or generate heat.



■ Do not allow the battery pack to come into contact with fresh or salt water, or allow the terminals to become wet.

- If the safety mechanisms and protective devices are damaged by corrosion, an abnormal chemical reaction may occur inside the battery pack, or cause the battery pack to catch fire, explode, leak or spew battery fluid, or generate heat.



■ Cautions regarding the correct environment for using and storing the battery pack

● Temperature when using or recharging: 0 to 40°C

Do not use, recharge, store or leave the battery pack near fire or inside a car exposed to the hot sun, etc. (locations in which the temperature reaches 60°C or higher).

At high temperatures, the safety mechanisms and protective devices inside the battery pack may be damaged by corrosion, causing an abnormal chemical reaction to occur, or cause the battery pack to catch fire, explode, leak or spew battery fluid, or generate heat. If the safety mechanisms and protective devices are damaged, the battery pack will become unusable.

An environment with extremely high or low temperatures will cause the battery capacity to deteriorate and shorten the usable time, and may even shorten the battery life.

Avoid storing the battery pack with it near full charge. It is recommended to store the battery pack when it is near fully discharged.

If the battery pack is completely discharged, it may become unable to be recharged again. To avoid this, charge the battery pack for at least five minutes every six months.

● Storage temperature: -10°C to 30°C

When not using the battery pack, remove it from the camera and store at -10°C to 30°C in a place with no condensation.

● Humidity: 10% to 90% (no condensation)

USING YOUR DIGITAL CAMERA SAFELY AND CORRECTLY

Concerning the Lithium-ion battery pack (Model DB-L10) (continued)

DANGER

■ Use only the supplied battery pack charger (Model VAR-L10)

- If another charger is used, the battery pack may be overcharged, or recharged with an abnormal voltage, causing an abnormal chemical reaction to occur, or cause the battery pack to catch fire, explode, leak or spew battery fluid, or generate heat.



■ Use the battery pack only in the specified device

- If the battery pack is used in a device other than that specified, it may cause an abnormal voltage flow, or cause the battery pack to catch fire, explode, leak or spew battery fluid, or generate heat.



■ Do not peel or damage the outer case

- Damaging the outer case, inserting nails, hitting with a hammer, stepping on the battery pack, etc. may cause a short circuit inside the battery pack or cause the battery pack to catch fire, explode, leak or spew battery fluid, or generate heat.



■ If the battery pack is leaking and the electrolyte gets on your skin or clothing, immediately rinse with clean water.

- If the electrolyte gets into your eyes, you risk losing your eyesight. Immediately rinse your eyes with clean, running water, and seek medical attention right away. Any electrolyte that comes into contact with your skin or clothing may harm your skin. Immediately rinse the area with clean, running water.



■ Insert the battery pack correctly, as specified

- When installing the battery pack in the charger or camera, pay attention to the indicated polarity ((+) and (-)), and insert it correctly.
- If the battery pack is installed with the wrong orientation, it may cause an abnormal chemical reaction while in the charger, an abnormal voltage flow when it is used, or cause the battery pack to catch fire, explode, leak or spew battery fluid, or generate heat.



WARNING

■ Always stop the recharging after the prescribed recharge time, even if the battery pack is not fully charged.

- If you continue to recharge the battery pack, it may cause the battery pack to catch fire, explode, leak or spew battery fluid, or generate heat.



■ Keep out of the reach of children.

- They may handle the battery pack in an unforeseeable manner that results in damage.



CAUTION

■ Charge the battery pack before using it

- Always recharge the battery pack before using it for the first time, or when using it after it has been kept in storage for a long time. During recharging, the battery pack may be warm. This is normal and does not indicate a malfunction.



■ Note concerning the battery pack after use

- The battery pack may be warm immediately after the digital camera is used. If removing the battery pack, turn off the digital camera and allow the battery pack to cool down before removing it.



■ Recycling the battery pack

- To conserve the environment and for efficient use of natural resources, please discharge the used battery pack, cover the (+) and (-) terminals with tape and recycle the insulated battery pack.
- If disposing of the battery pack as unburnable trash, please follow all applicable regulations of your area.



USING YOUR DIGITAL CAMERA SAFELY AND CORRECTLY

Concerning the accessories

CAUTION

■ Cautions concerning the use of the AC adapter

- Use only the separately sold AC adapter (model VAR-G6EX for the VPC-MZ3EX/VPC-MZ3GX, model VAR-G6E for the VPC-MZ3EX [for U.K.] and model VAR-G6U for the VPC-MZ3/VPC-MZ3GX) with your digital camera. Do not use an AC adapter other than the one indicated here, designed for specific use with your digital camera.
- If an AC adapter other than the specified one is used, it may damage the digital camera and cause a fire or electric shock.
- Normally when using an AC adapter, remove the battery pack. Otherwise the battery pack may cause excess heat, leakage, injury or damage to nearby objects.
- For complete information on how to use the AC adapter, refer to the instructions accompanying it.

■ Cautions concerning the CompactFlash and Microdrive

- Immediately after use, the CompactFlash and Microdrive will be very hot. Before removing the CompactFlash or Microdrive, turn off the digital camera and wait for the temperature to cool down.
- Keep out of the reach of children. Young children may put the media in their mouth and choke or cause some other unexpected injury or accident.
- A CompactFlash is not included with Model VPC-MZ3GX.

FOR CORRECT USE OF YOUR CAMERA

■ Cautions before capturing important images

- Before capturing important images, make sure that the digital camera is operating properly and in condition to capture the image properly.
- Sanyo Electric shall not be held responsible for any losses that result from images that could not be recorded, are erased, destroyed, or damaged in any way due to a problem with the digital camera, any of its accessories, or its software.

■ Cautions concerning copyrights

- The images you capture with your digital camera are for your own private use, any other use may violate the rights of copyrights owners.

■ Cautions when cleaning the digital camera

Cleaning procedure

- 1 Turn off the digital camera and remove the battery pack.
- 2 Remove the dirt with a soft cloth.
- 3 If the digital camera is extremely dirty, wipe with a soft cloth moistened with a mild detergent diluted with water and wrung dry.

Caution

- Do not use benzene or thinner products to clean the digital camera. Doing so may cause deformation, discoloration, or paint peeling. When using a chemically treated cloth, carefully read its instructions and warnings.
- Do not spray insecticides or volatile sprays on the digital camera. Do not let rubber or vinyl objects contact the digital camera for a long period. They may cause deformation, discoloration, or paint peeling.

■ Cautions when cleaning the lens

- If the lens gets dirty, use a commercially available air blower or a cleaning cloth for photographic equipment to clean it.

USING YOUR DIGITAL CAMERA SAFELY AND CORRECTLY

FOR CORRECT USE OF YOUR CAMERA (continued)

CAUTION

■ When not using the digital camera for a long period

- Remove the battery pack. However, when the battery pack is removed for a long time, the digital camera functions may begin to not work properly. Periodically reinstall the battery pack and check the digital camera functions.
- If the battery pack is left in the digital camera, a small amount of power is still used even if the digital camera is turned off. If the battery pack is left in the digital camera for a long period, it may become completely discharged and lose its ability to be recharged again.

■ Cautions concerning condensation

- Using the digital camera with condensation inside it may damage the digital camera.

If condensation seems likely to form

- Place the digital camera in a plastic bag and seal it, and then wait until the digital camera has reached the ambient temperature.

Be careful of condensation under the following conditions

- When moving the digital camera suddenly from a cold place to a warm place.
- When the ambient temperature changes drastically, such as when a heater is turned on to quickly heat the room.
- When the digital camera is placed in the path of cool air from an air conditioner.
- When the digital camera is placed in a location of high humidity.

■ Cautions concerning undesired interference

- The digital camera may create undesired interference if used close to a television or radio. To avoid this type of interference, make sure the cores on the supplied AV cable and USB interface cable are not removed.

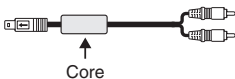

Dedicated AV cable

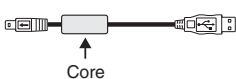

Dedicated USB interface cable

■ Cautions concerning magnetism

- Do not place credit cards, bank cards, floppy disks, or other items that may be damaged by magnetic fields near the speaker. Data may be lost or the magnetic strips on cards may be damaged.

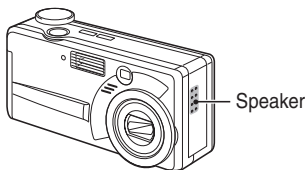

■ Cautions concerning data storage

- It is recommended that any important data be copied onto a separate media (such as a hard disk, MO disk, or CD-R disk).
- Stored data may be lost (or corrupted) in cases such as those listed below. Sanyo Electric will not be held responsible for any damage or lost profits arising from the loss of data.
 - If the card is used incorrectly.
 - If the card is not inserted correctly into the digital camera.
 - If the card is subjected to electrical or mechanical shocks or other forces.
 - If the card is removed from the digital camera or if the digital camera is turned off during reading or writing operations.
 - If the card has reached the end of its usable life.

USING YOUR DIGITAL CAMERA SAFELY AND CORRECTLY

FOR CORRECT USE OF YOUR CAMERA (continued)





CAUTION

■ Cautions when handling the cards

- The cards are precision devices. Do not bend, drop, or subject them to strong forces or shocks. Be especially careful with the Microdrive, for it is easily damaged by vibrations.
- Avoid using or storing the cards in places with extremely high or low temperatures, subject to direct sunlight, in a completely closed vehicle, near air conditioners or heaters, or in humid or dusty locations.
- Avoid using or storing the cards in locations where strong static electrical charges or electrical noise can be easily generated.
- Do not allow the edges of the cards to become contaminated with foreign materials. Gently wipe away any contamination with a soft, dry cloth.
- When not using the cards, put them back into their protective covers to protect them from damage due to static electricity.
- Do not carry the cards in trouser pockets, as the cards may become damaged when you sit down or make other movements that may apply forces.
- Before using a new card, be sure to format it using the digital camera (see "FORMATTING A CARD" on page 35).
- When buying separately sold or commercially available products, carefully read the instructions and warnings that come with them.

CAUTIONS CONCERNING HIGH TEMPERATURES

■ icon

- The  icon indicates that the temperature inside the camera in use is high. If the  icon appears, it is still possible to use the camera for a short while, after which the  icon will flash and the camera will become inoperable. If this happens, discontinue using the camera as soon as possible, and wait until the internal temperature falls before using it again. Note that especially when shooting video clips, soon after the  icon lights, the remaining shooting time will appear, and when that figure becomes 00, further shooting is impossible.



<High temperature alert>

CHECKING THE INCLUDED ACCESSORIES

- Handstrap

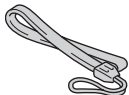

- Software: 1 CD-ROM



- CompactFlash (16MB): 1
A CompactFlash is not included with Model VPC-MZ3GX.

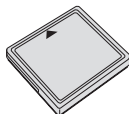

- Lithium-ion battery pack (battery pack): 1

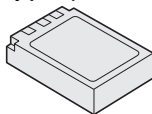

- Lithium-ion hydride battery pack charger and power cord

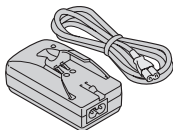

- Dedicated AV cable: 1

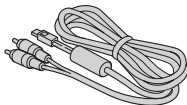

- Dedicated USB interface cable: 1

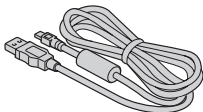

- Soft case

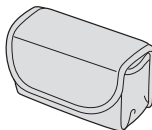

ATTACHING THE HANDSTRAP

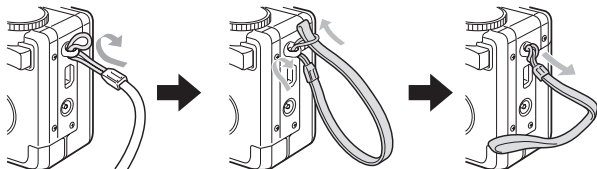

SOFT CASE

When not using the digital camera, keep it in the soft case for protection.

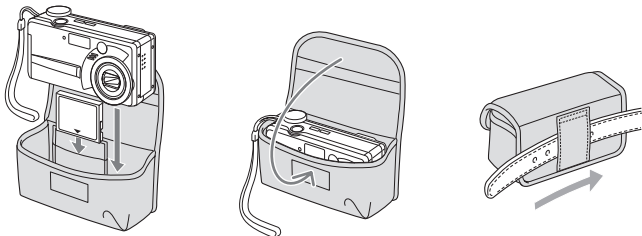

Media cards that can be used with this digital camera

The types of card that can be inserted into and used with this digital camera are:

- **CompactFlash**

A CompactFlash is not included with Model VPC-MZ3GX.

- **Microdrive**

There are special precautions that must be followed when using Microdrive cards. Before using Microdrive cards, carefully read “Cautions when using the Microdrive” (see page 210).

What “card” means in this manual

- In this manual, CompactFlash and Microdrive cards that can be used in this digital camera are referred to as “card”.
- The cards in the illustrations in this manual are CompactFlash cards, but all installation, removal, and formatting procedures are the same for both the CompactFlash and Microdrive cards.

QUICK START FOR CAPTURING IMAGES

1 Charge the battery pack

- Before using the supplied battery pack in the camera, insert it into the charger.
- Insert it in the direction indicated by the [▲] mark on the battery pack.

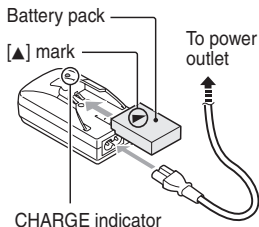

2 Connect the supplied power cord to the battery pack charger.

- Insert the connector straight and securely.

3 Plug the power plug into a power outlet (AC 100 to 240V).

- Recharging begins.
- During recharge, the CHARGE indicator is lit red.

4 When the CHARGE indicator lights green, unplug the power cord from the power outlet, and remove the battery pack from the charger.

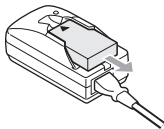

HINT

- Please read the safety precautions regarding the battery pack (see page 15) and the supplied battery pack charger (VAR-L10) (see page 11).
- The recharge time is approx. 120 minutes.

Install the battery pack and card

The card can be used after it has been formatted with the camera (see **FORMATTING A CARD** on page 35). Be sure to turn off the power before installing or removing the card.



Use the battery pack recharged in step 1 above.

Make sure that the battery pack polarity ((+) and (-)) and the card orientation are correct.

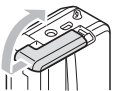
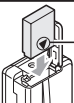
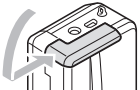
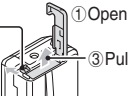
5 Insert the battery pack.

1  <p>Open battery compartment cover on the digital camera side.</p>	2  <p>Insert the battery pack.</p>
3  <p>Close the battery compartment cover.</p>	<ul style="list-style-type: none">When removing the battery pack...  <p>① Open ② Push in ③ Pull out</p>

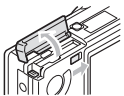
6 Insert the card

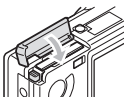
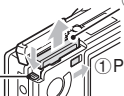
1  <p>Push the card cover lever.</p>	2  <p>Insert the card all the way.</p>
3  <p>Close the card cover.</p>	<ul style="list-style-type: none">When removing the card...  <p>① Push ② Push in ③ Pull out</p>

QUICK START FOR CAPTURING IMAGES

Capture an image (details on page 60)

Now that preparation is completed, your digital camera is ready to capture images. Shown here is how to capture a still image.

7 Set the main switch to [].

8 Turn the selector dial to [].

9 Press the power button.

- The power turns on.
 - The lens extends.
 - When the standby indicator lights green, the camera is ready to capture an image.
-

10 Point the camera lens at the subject.

- Compose the picture by viewing the LCD monitor.

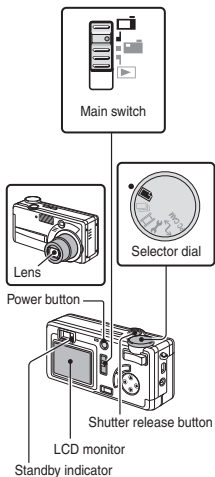

11 Press the shutter release button halfway (focus-lock).

- The autofocus locks on the subject, and the image in the LCD monitor appears clearly.

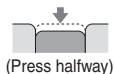

12 Continue to gently press the shutter release button all the way.

- The image is captured.

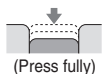

View the image (details on page 87)

Now let's take a look at the image you captured.

13 Set the main switch to [▶].

- The image you captured appears in the LCD monitor.
- Press [◀] or [▶] on the arrow button to display the images stored before or after the current image.



Main switch

Power button

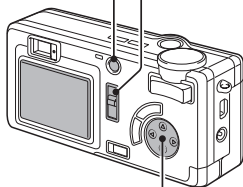

Arrow button

14 When you are finished, press the power button to turn off the digital camera.

HINT

- For still images, you can view the captured image on the LCD monitor by keeping the shutter release button depressed when you capture the image.
- When the standby indicator is flashing red, the next image cannot be captured. When the standby indicator lights green again, it is possible to capture the next image.

PARTS NAMES

Front

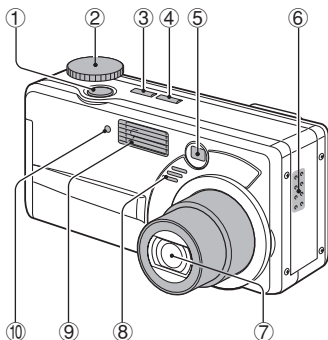

① Shutter release button

② Selector dial

③ Flash button

④ Focus button

⑤ Viewfinder

⑥ Speaker

⑦ Lens (closed when the lens is stowed)

⑧ Microphone

⑨ Flash

⑩ Self-timer indicator

Rear

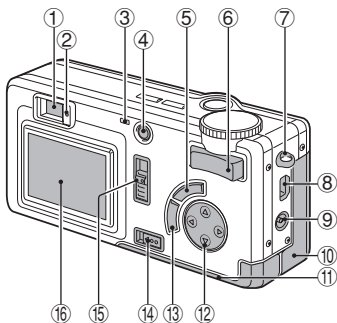

① **Viewfinder**

② **Standby indicator (red/green)**

Red flashing:

- When capturing an image, recording sound, charging the flash, storing an image or sound recording, when no card is installed (indicates that image or sound cannot be recorded), or recording using the self-timer

Red steady:

- When the memory is full (indicates that image or sound cannot be recorded), or recording using the self-timer

Green flashing:

- When using the exposure correction or digital zoom functions (indicates that image and sound can be recorded)

Green steady:

- Image and sound can be recorded, or when connected to a PC

③ **Accessing indicator**

④ **Power button**

⑤ **SET button**

⑥ **Zoom switch**

⑦ **Handstrap holder**

⑧ **DIGITAL/AV terminal**

- Used as both the USB connector and AV output terminal.

⑨ **DC IN (external DC power input) terminal**

- For connecting a separately sold AC adapter

⑩ **Battery compartment cover**

⑪ **Card cover**

⑫ **Arrow button**

⑬ **MENU button**

⑭ **Card cover lever**

⑮ **Main switch**

⑯ **LCD monitor**

RECHARGING THE BATTERY PACK

Be sure to fully charge the supplied or separately sold battery pack before using it in your camera. For charging the battery pack, use the supplied charger.

Charge the battery pack if it is being used for the first time, and recharge it whenever the remaining charge is low (see "CHECKING THE REMAINING BATTERY PACK CHARGE" on page 182).

- During recharging, the charger and battery pack will be warm. This is normal and does not indicate a malfunction.

If there is interference to your TV or radio during recharging...

- Move the battery pack and charger further away from the TV or radio.

Ambient temperature during recharging

- It is recommended that the ambient temperature during recharging be between about 10°C and 35°C. Due to the characteristics of the battery pack, at temperatures below 10°C, it may not be possible to sufficiently recharge it.

Recharge a battery pack in the following cases

- A battery pack which has not been used for a long time
- Newly purchased battery pack

About the CHARGE indicator

The CHARGE indicator shows the status of the battery pack and the charger. Please refer to the following table if the indicator flashes abnormally.

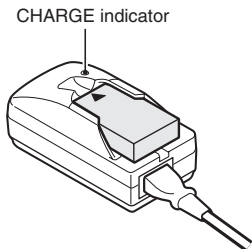

CHARGE indicator	
Not lit	Not connected properly <ul style="list-style-type: none">● To recharge the battery pack, the power cord of the charger must be connected to a power outlet, and the plug at one end inserted in the charger's power socket (see page 32).● The battery pack is not installed, or it is not installed correctly (see page 27).
Lit red	Recharging
Lit green	Recharging finished
Red flashing	Problem with the battery pack <ul style="list-style-type: none">● Immediately remove the battery pack from the charger.● Do not use an abnormal battery pack. (The usable life of the battery pack has probably expired.)



FORMATTING A CARD

Before using a card, it must be formatted with this camera:

- After purchasing, when used for the first time
- If it was formatted using a personal computer or another digital camera.

For more information on handling the cards, see “Cautions when handling the cards” on page 23 and “Cautions when using the Microdrive” on page 210.

1 Display the Shooting Option Setting Screen (see page 39).

- Set the main switch to [], and turn the selector dial to [].

2 Press [▼] on the arrow button to select the reformat icon .

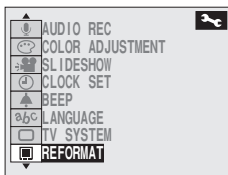

3 Press the SET button.

- The Reformat Screen appears.

4 Press [▲] on the arrow button to select “YES”.

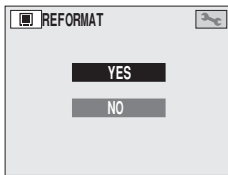

5 Press the SET button.

- Reformatting begins.
- During reformatting, “REFORMATTING” and “DO NOT POWER OFF” are shown on the LCD monitor.
- When reformatting is finished, you are returned to the Shooting Option Setting Screen.

CAUTION

Cautions during reformatting

- Do not turn off the power to the camera or eject the card during reformatting.

Reformatting erases the data

- When a card is reformatted, all data recorded on the card is erased. Protected data (see page 159) is also erased, so before reformatting a card, any data you wish to keep should be copied to your personal computer's hard disk or other storage medium.

HINT

To cancel reformatting

- In step 4, select "NO", and press the SET button. You are returned to the Shooting Option Setting Screen.

Reformatting is also possible in the playback mode

- Reformatting can also be executed if the main switch is set to [▶] in step 1 above to display the Playback Option Setting Screen.

NOTE

- By using the card together with a commercially available PC card adapter for CompactFlash cards, the card can be used as a PC card conforming to PC Card Standard-ATA.

TURNING THE POWER ON/OFF

Turning the power on

When capturing images

- 1 Set the main switch to [] or [].**
 - []: The LCD monitor is used.
 - []: The LCD monitor is not used.
- 2 Turn the selector dial to [], [] or [].**
- 3 Press the power button.**
 - The power turns on, the lens extends and the standby indicator next to the viewfinder lights.
 - If the main switch is set to [], an image appears on the LCD monitor.

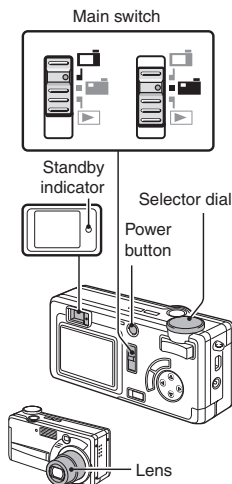

When playing back images

- 1 Set the main switch to [].**
- 2 Press the power button.**
 - The power turns on, and an image appears on the LCD monitor.

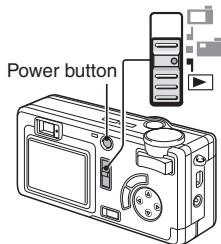

Turning the power off

1 Press the power button.

- The power turns off.

When capturing images

- The lens automatically retracts and closes.
- The standby indicator turns off.
- The LCD monitor turns off.
- The power turns off.

When playing back images

- The LCD monitor turns off.

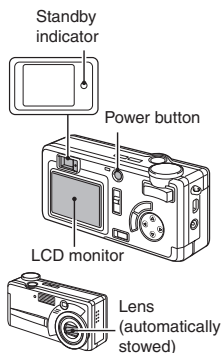

Turning the power on when the power save function is active

In order to save the battery pack power, the power save function will automatically turn off the power after one minute of no use during shooting, or five minutes of no use during playback (factory-preset setting).

1 Press the MENU button, the power button or the shutter release button once.

HINT

- When using the separately sold AC adapter (model VAR-G6EX for the VPC-MZ3EX/VPC-MZ3GX, model VAR-G6E for the VPC-MZ3EX [for U.K.] and model VAR-G6U for the VPC-MZ3/VPC-MZ3GX), the power save function will become active after about 30 minutes of inactivity (factory-preset setting).
- The user can specify the time elapsed before the power save function is activated (see page 177).
- In the PC connection mode and PC camera mode, while the camera is connected to a personal computer with the dedicated USB interface cable, the power save function is disabled.

SETTING SCREENS AND OPTION SETTING SCREENS

For both shooting and playback, there are Setting Screens and Option Setting Screens.

Displaying and exiting the Shooting/Playback Setting Screens and Option Setting Screens

Displaying a Setting Screen

1 Set the main switch.

[]: To display the Shooting Setting Screen or Shooting Option Setting Screen.

[]: To display the Playback Setting Screen or the Playback Option Setting Screen.

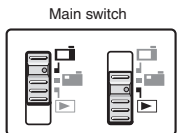



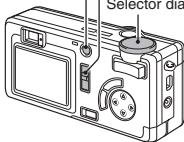

Power button

Selector dial



2 Turn the selector dial to the mark for the desired setting screen.



	Shooting	Playback
	Still Image Shooting Setting Screen (page 45)	Still Image Playback Setting Screen (page 53)
	Sequential shots Shooting Setting Screen (page 47)	Sequential shots Playback Setting Screen (page 53)
	Video Clip Shooting Setting Screen (page 49)	Video Clip Playback Setting Screen (page 53)
	Shooting Option Setting Screen (page 54)	Playback Option Setting Screen (page 54)
	PC connection mode (page 166)	PC connection mode (page 166)
PC CAM	PC camera mode (page 167)	PC camera mode (page 167)

3 Turn on the power.

- In step 2, if the selector dial is set to [], the Shooting Option Setting Screen or Playback Option Setting Screen appears.

4 Press the MENU button.

- The setting screen selected in step 3 appears.

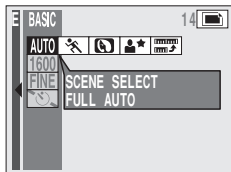

Example: Still Image Shooting
Mode Setting Screen
(BASIC mode)

Exiting the Shooting/Playback Setting Screen

1 Press the MENU button.

- The Shooting/Playback Setting Screen is exited.

Exiting the Shooting/Playback Option Setting Screen

1 Turn the selector dial to a mark other than [].

- The Option Setting Screen is exited and either a Shooting Screen or Playback Screen appears.

HINT

- For more information on using the setting screens, see “Switching between the operation modes” on page 41 and “Setting screen basic operation” on page 43.
- In the PC connection mode and PC camera mode, the LCD monitor turns off.

SETTING SCREENS AND OPTION SETTING SCREENS

Switching between the operation modes (BASIC mode and EXPERT mode)

This camera allows you to choose between two operation modes: with the BASIC mode, you can enjoy taking photos while letting the camera do all the work; in the EXPERT mode, you have control of all the camera settings. Select the operation mode for the type of photography you enjoy.

1 Display the Shooting Setting Screen.

- The BASIC Mode Shooting Setting Screen or the EXPERT Mode Shooting Setting Screen appears.

2 Press [◀] on the arrow button twice.

- The operation mode is switched.
- To return to the initial operation mode, again press [◀] on the arrow button twice.

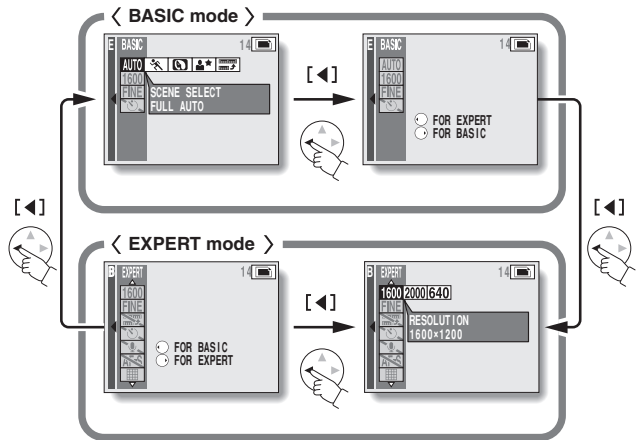

Shooting in the BASIC mode

In the BASIC mode the number of settings the user has to deal with are few, making it easy for the novice digital camera operator to enjoy taking photos. It is recommended that the user who is new to digital camera operation or not familiar with the various settings take photos using the basic settings of this mode. In addition, if you change the settings and find that the resulting images are not satisfactory, try returning to the basic settings to take the photos.

BASIC mode settings

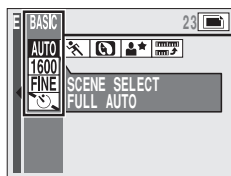

- AUTO** : Scene select setting
- 1600** : Resolution setting
- FINE** : Compression rate setting
-  : Self-timer setting

<Still image shooting>

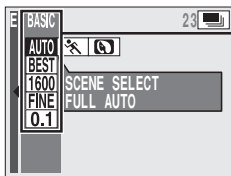

- AUTO** : Scene select setting
- BEST** : Sequential shots mode setting
- 1600** : Resolution setting
- FINE** : Compression rate setting
- 0.1** : Sequential shots interval setting

<Sequential shots shooting>

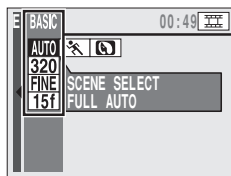

- AUTO** : Scene select setting
- 320** : Resolution setting
- FINE** : Compression rate setting
- 15f** : Frame rate setting

<Video clip shooting>

SETTING SCREENS AND OPTION SETTING SCREENS

Setting screen basic operation

When a setting screen is displayed, the arrow button and the SET button are used to make the desired settings.

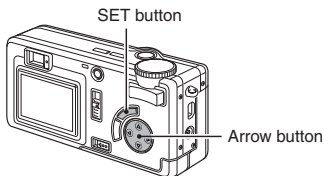

■ Shooting Setting Screen

● When selecting a menu

- Press [▲] or [▼] on the arrow button.

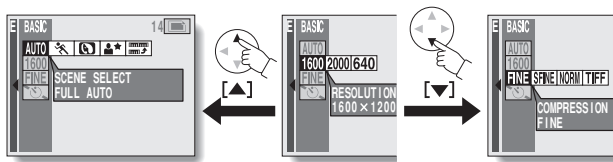

● When selecting a setting (icon)

- Press [◀] or [▶] on the arrow button.
- To make a setting, select the desired icon, and press the SET button. When the setting is established, the selected icon moves to the left end of the line-up.

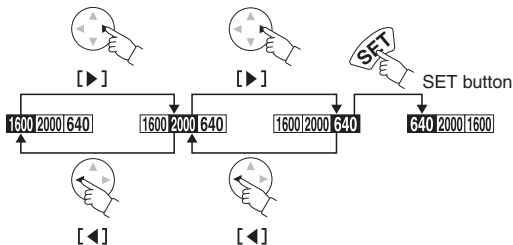

■ Playback Setting Screen

● When selecting a setting (icon)

- Press [▲] or [▼] on the arrow button.

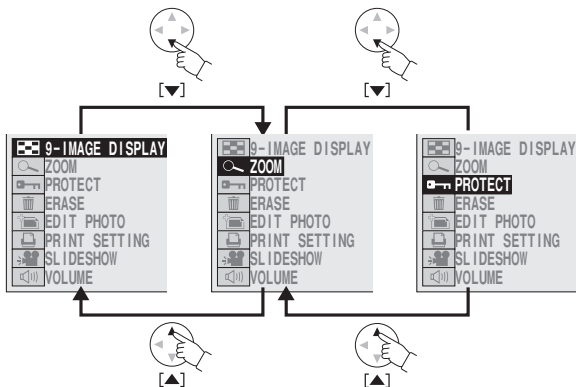

■ Other operations

● To change a numerical value

Press [▲] or [▼] on the arrow button to change the number.

● To return to the previous operation

- Press the MENU button.
- Select "EXIT" or the **EXIT** icon, and press the SET button.

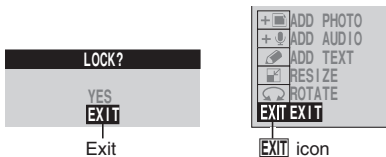

SETTING SCREENS AND OPTION SETTING SCREENS

Shooting Setting Screens

Still Image Shooting Setting Screen

* All the icons never appear at the same time.

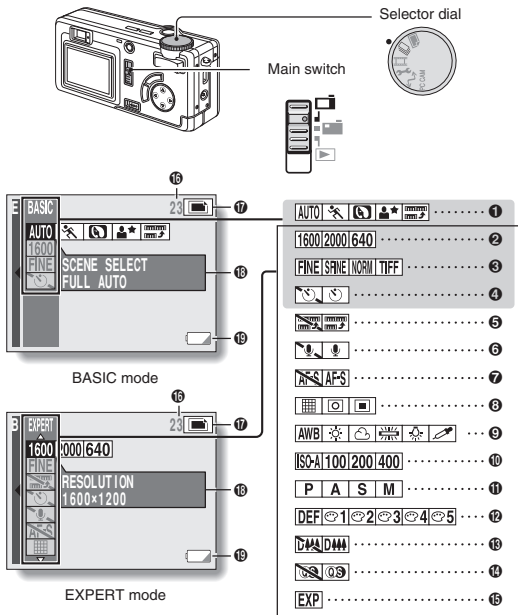





1 Scene Select menu (page 77)

- ▶ **AUTO**: Full auto icon
- ▶ : Sports scene icon
- ▶ : Portrait icon
- ▶ : Night scene icon
- ▶ : Wide-range shot icon



2 Resolution menu (page 79)

- ▶ **1600**: 1600 x 1200-pixel resolution icon
- ▶ **2000**: 2000 x 1496-pixel resolution icon
- ▶ **640**: 640 x 480-pixel resolution icon



3 Compression menu (page 82)

- ▶  FINE: FINE icon (low compression)
- ▶  SFINE: SFINE icon (super-low compression)
- ▶  NORM: NORM (NORMAL) icon (moderate compression)
- ▶  TIFF: TIFF icon (no compression)



4 Self-timer menu (page 80)

- ▶  Self-timer off icon
- ▶  Self-timer on icon



5 Wide-range menu (page 103)

- ▶  Wide-range shot off icon
- ▶  Wide-range shot on icon



6 Voice Memo menu (page 104)

- ▶  Voice memo off icon
- ▶  Voice memo on icon







7 Spot focus menu (page 105)

- ▶  Spot focus off icon
- ▶  Spot focus on icon





8 Light-measuring mode (EXP MEASURE) menu (page 106)

- ▶  Multi-section light-measuring icon
- ▶  Center-weighted light-measuring icon
- ▶  Spot light-measuring icon





9 White Balance menu (page 107)

- ▶  AWB: Auto white balance icon
- ▶  Fair icon
- ▶  Overcast icon
- ▶  Fluorescent lighting icon
- ▶  White (incandescent) light icon
- ▶  Color fill icon



10 ISO sensitivity menu (page 109)

- ▶  ISO-A: Auto sensitivity icon (ISO100 to 200)
- ▶  100: ISO100 icon
- ▶  200: ISO200 icon
- ▶  400: ISO400 icon



11 Exposure control menu (page 110)

- ▶  P: Program AE icon
- ▶  A: Aperture priority AE icon
- ▶  S: Shutter speed priority AE icon
- ▶  M: Manual exposure control icon



12 Color correction menu (page 121)

- ▶  DEF,  C1 to  C5: Color correction icons (DEF is the factory-set initial setting)

13 Digital Zoom menu (page 122)

- ▶  DMM: Digital zoom off icon
- ▶  DMM: Digital zoom on icon

14 Quick Shot menu (page 123)

- ▶  QS: Quick Shot off icon
- ▶  QS: Quick Shot on icon

15 Exposure correction icon (page 124)

16 Number of remaining images that can be captured (page 184)

17 Still image shooting mode icon (page 51)

18 Help display (page 175)

19 Remaining battery pack charge (page 182)

Not displayed when the remaining battery pack charge is near full or when the AC adapter (sold separately) is used.

▶ indicates the factory-preset setting.

SETTING SCREENS AND OPTION SETTING SCREENS

Sequential Shots Shooting Setting Screen

* All the icons never appear at the same time.

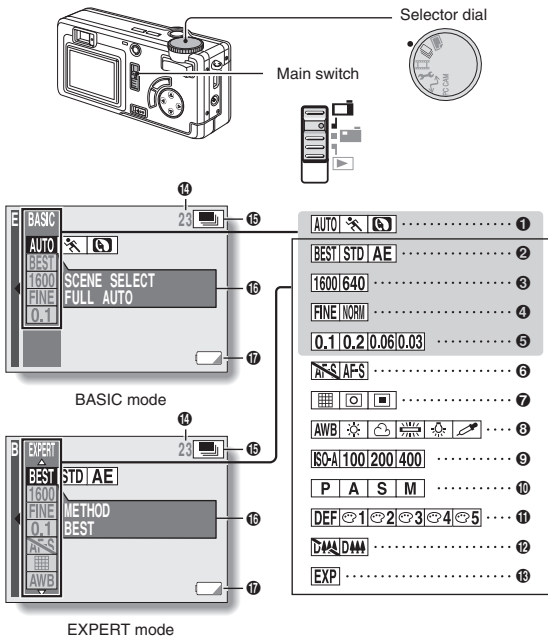



1 Scene Select menu (page 77)

- ▶ **AUTO**: Full auto icon
- ▶ : Sports scene icon
- ▶ : Portrait icon



2 Sequential shots mode (METHOD) menu (page 61)

- ▶ **BEST**: Best select shot icon
- ▶ **STD**: Standard sequential shots icon
- ▶ **AE**: AE shift sequential shots icon





3 Resolution menu (page 79)

- ▶  1600: 1600 x 1200-pixel resolution icon
-  640: 640 x 480-pixel resolution icon



4 Compression menu (page 82)

- ▶  FINE: FINE icon (low compression)
-  NORM: NORM (NORMAL) icon (moderate compression)



5 Sequential shots interval menu (page 62)

- ▶  0.1: 0.1 second-interval frame icon
-  0.2: 0.2 second-interval frame icon
-  0.06: 0.06 second-interval frame icon
-  0.03: 0.03 second-interval frame icon







6 Spot focus menu (page 105)

- ▶  AF-S: Spot focus off icon
-  AF-S: Spot focus on icon

7 Light-measuring mode (EXP MEASURE) menu (page 106)





- ▶  Multi-section light-measuring icon
-  Center-weighted light-measuring icon
-  Spot light-measuring icon

8 White Balance menu (page 107)





- ▶  AWB: Auto white balance icon
-  Fair icon
-  Overcast icon
-  Fluorescent lighting icon
-  White (incandescent) light icon
-  Color fill icon

- ▶ indicates the factory-preset setting.



9 ISO sensitivity menu (page 109)

- ▶  ISO-A: Auto sensitivity icon (ISO100 to 200)
-  100: ISO100 icon
-  200: ISO200 icon
-  400: ISO400 icon



10 Exposure Control menu (page 110)

- ▶  P: Program AE icon
-  A: Aperture priority AE icon
-  S: Shutter speed priority AE icon
-  M: Manual exposure control icon

11 Color correction menu (page 121)

-  DEF,  to : Color correction icons (DEF is the factory-set initial setting)

12 Digital Zoom menu (page 122)

- ▶  DMA: Digital zoom off icon
-  DMA: Digital zoom on icon

13 Exposure correction icon (page 124)

14 Number of remaining images that can be captured (page 184)

15 Sequential shots shooting mode icon (page 51)

16 Help display (page 175)

17 Remaining battery pack charge (page 182)

Not displayed when the remaining battery pack charge is near full or when the AC adapter (sold separately) is used.

SETTING SCREENS AND OPTION SETTING SCREENS

Video Clip Shooting Setting Screen

* All the icons never appear at the same time.

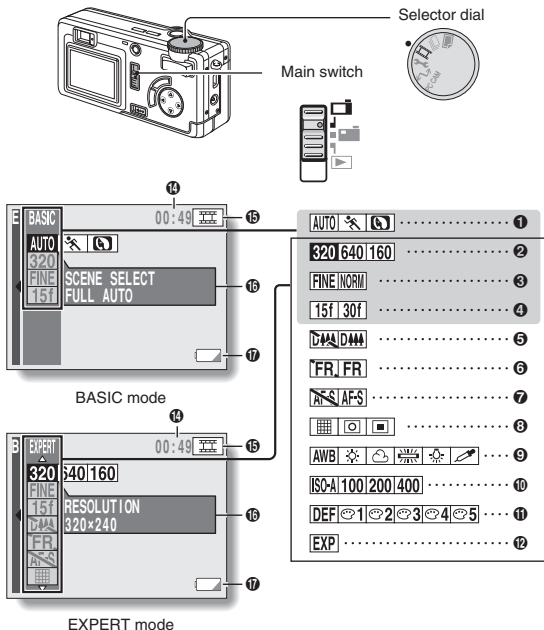



1 Scene Select menu (page 77)

- ▶ **AUTO**: Full auto icon
- ▶ : Sports scene icon
- ▶ : Portrait icon



2 Resolution menu (page 79)

- ▶ **320**: 320 x 240-pixel resolution icon
- ▶ **640**: 640 x 480-pixel resolution icon
- ▶ **160**: 160 x 120-pixel resolution icon



3 Compression menu (page 82)

- ▶  FINE icon (low compression)
-  NORM (NORMAL) icon (moderate compression)



4 Frame Rate menu (page 84)

- ▶  15 frames/sec icon
-  30 frames/sec icon



5 Digital Zoom menu (page 122)

- ▶  Digital zoom off icon
-  Digital zoom on icon



6 Flicker-reduction (FLICKER REDUCT) menu (page 125)

- ▶  Flicker-reduction function off icon
-  Flicker-reduction function on icon







7 Spot focus menu (page 105)

- ▶  Spot focus off icon
-  Spot focus on icon





8 Light-measuring mode (EXP MEASURE) menu (page 106)

- ▶  Multi-section light-measuring icon
-  Center-weighted light-measuring icon
-  Spot light-measuring icon





9 White Balance menu (page 107)

- ▶  Auto white balance icon
-  Fair icon
-  Overcast icon
-  Fluorescent lighting icon
-  White (incandescent) light icon
-  Color fill icon

10 ISO sensitivity menu (page 109)

- ▶  auto sensitivity icon (ISO100 to 200)
-  ISO100 icon
-  ISO200 icon
-  ISO400 icon

11 Color correction menu (page 121)

- ▶   to : Color correction icons ( is the factory-set initial setting)

12 Exposure correction icon (page 124)

13 Remaining recording time available (page 184)

14 Video clip shooting mode icon (page 51)

15 Help display (page 175)

16 Remaining battery pack charge (page 182)

Not displayed when the remaining battery pack charge is near full or when the AC adapter (sold separately) is used.

▶ indicates the factory-preset setting.

SETTING SCREENS AND OPTION SETTING SCREENS

Shooting status display

After you exit the Shooting Setting Screen, icons on the LCD monitor indicate the status of the digital camera and card. The icons and their positions differ depending on the selected shooting mode.

* All the icons never appear at the same time.

- ❶ Operation mode indicator
- ❷ Scene select indicator
- ❸ Spot focus indicator
- ❹ Light-measuring mode indicator
- ❺ White balance indicator
- ❻ ISO sensitivity indicator
- ❼ Exposure control indicator
- ❽ Aperture indicator
- ❾ Shutter speed indicator
- ❿ Light-measuring spot mark
- ⓫ Focus mark
- ⓬ Number of images remaining
- ⓭ Shooting mode indicator
- ⓮ Flash mode indicator
- ⓯ Focus mode indicator
- ⓰ Self-timer indicator
- ⓱ Voice memo indicator
- ⓲ Quick Shot indicator
- ⓳ Color correction indicator
- ⓴ Exposure correction indicator
- ⓵ Remaining battery pack charge
- ⓶ Zoom bar

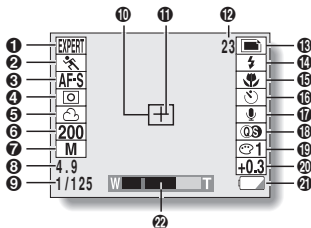

<Still image shooting status display>

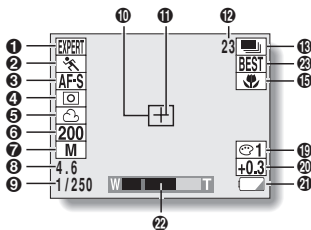

<Sequential shots shooting status display>

- ⑫ Sequential shots mode indicator
- ⑭ Flicker-reduction indicator
- ⑮ Remaining shooting time

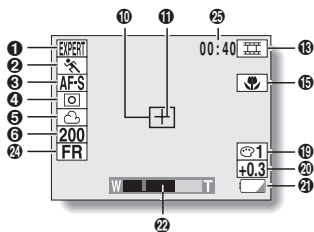

<Video clip shooting status display>

SETTING SCREENS AND OPTION SETTING SCREENS

Playback Setting Screens

Still Image Playback Setting Screen



Main switch



Selector dial



Sequential Shots Playback Setting Screen



Main switch



Selector dial

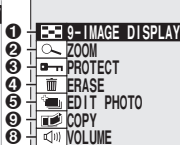

Video Clip Playback Setting Screen



Main switch



Selector dial

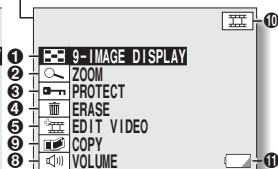

- 1 9-image display playback
- 2 Playback zoom
- 3 Protect
- 4 Erase icon
- 5 Edit still image icon
(during the video clip playback, the edit video icon is displayed)
- 6 Print settings
- 7 Slideshow playback
- 8 Volume control
- 9 Image copy

- 10 Playback mode indicator
 - : Still image playback
 - : Sequential shots playback
 - : Video clip playback
- 11 Remaining battery pack charge
Not displayed when the remaining battery pack charge is near full or when the AC adapter (sold separately) is used.

Shooting/Playback Option Setting Screens

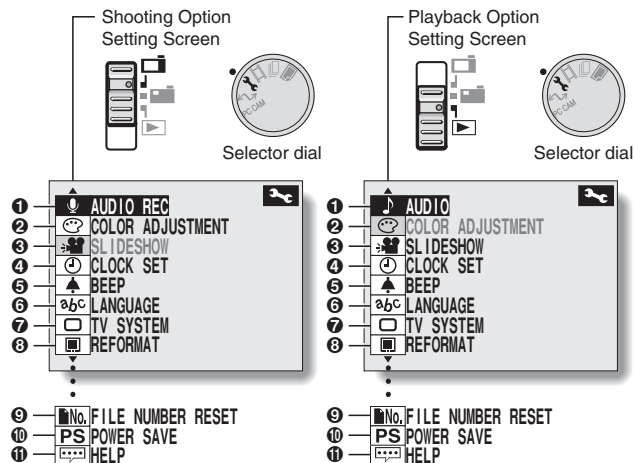

1 Audio recording

On the Playback Option Setting Screen, the audio playback icon  is shown.

2 Color correction setting (real color equalizer)

Cannot be selected from the Playback Option Setting Screen.

3 Slideshow settings

Does not appear on the Shooting Option Setting Screen.

4 Date and time setting

5 Operational sound (beep) settings

6 Display language selection



7 TV system selection

8 Card reformat

9 File number reset setting

10 Power save function

11 Help display

Icons 9 to 11 are displayed when you press  or  on the arrow button to scroll down the screen.

BEFORE TAKING PICTURES

For best results

Holding the camera

Hold the camera securely with both hands, keeping your elbows close to your body and making sure the camera is stable.

Correct hold



Incorrect hold



A finger is blocking the lens.

Make sure that the lens and flash are not blocked by your fingers or the handstrap.

HINT

- When a picture is taken with the camera held vertically, the image played back on the LCD monitor screen or on a TV set will be shown on its side. However, images captured in the still image shooting mode or sequential shots shooting mode can be rotated when they are played back (see page 98). Note that video clips cannot be rotated when they are played back.

USING THE AUTOFOCUS

The autofocus will work in almost all situations; however, there are certain conditions that may cause the autofocus function to not work properly. If the autofocus function is not working properly, use the manual focus mode to capture images (see page 72).

■ Conditions that may cause incorrect focus

The following examples are some of the situations where the autofocus function may not work.

- **Subjects with low contrast, very bright subjects at the center of the image, or dark subjects or locations**

Use the focus-lock function (see page 60) to lock the focus on an object with contrast at the same distance as the desired subject.



- **Subjects without vertical lines**

Use the focus-lock function to lock the focus on the subject while holding the digital camera vertically.

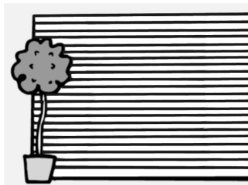

The following examples are some of the situations where the autofocus function may work, but not as desired.

- **When both near and far objects are present**

Use the focus-lock function to lock the focus on an object at the same distance as the desired subject.



BEFORE TAKING PICTURES

● **Fast-moving subjects**

Use the focus-lock function to lock the focus on an object at the same distance as the desired subject.



Hints for taking pictures

Operational sound

- The camera can be set so that a sound is heard, for example, when the power is turned on or off, or the shutter release button, SET button, or MENU button is pressed (see page 172).

Saving battery pack power

- When you take pictures without using the LCD monitor, you can slow down the rate of battery pack consumption (see page 75).

Immediate viewing of captured images

- After taking a picture, you can move the main switch to [▶] to view the last image captured.

Don't miss a photo chance

- In a digital camera, there is a slight delay after the shutter release button is pressed before the image is actually captured. To counter this delay when taking sequential shots pictures, follow these steps.
 - ① With the shutter release button pressed halfway, wait for the exact moment to take the picture.
 - The camera prepares to capture an image (precapture function).
 - ② At the moment you want to take the picture, continue to gently press the shutter release button all the way.
 - Sequential shots shooting begins at the moment the shutter release button is fully pressed.

Quick exposure correction setting (EXPERT mode only)

- When a Shooting Setting Screen or Shooting Information Screen is not shown, press [◀] or [▶] on the arrow button to immediately access the exposure correction icon and exposure correction bar, and adjust the setting. (The icon will not appear in cases where the setting cannot be adjusted.) The exposure correction icon and exposure correction bar are canceled when the MENU button is pressed (see page 124).

Where is the image and audio data saved?

- All the image and sound data is recorded on the card installed in the camera (see page 164).

Taking pictures in backlight conditions...

- When taking pictures with the light coming from behind the subject, due to the characteristics of the lens, light lines or patterns (flare phenomenon) may appear in the captured image. In this situation, it is recommended that you avoid taking pictures with the subject lit from behind.

NOTE

The field of view differs depending on the shooting mode

- Even at the same camera angle, at a resolution of [1600] in the still image and sequential shots shooting modes, and at a resolution of [640] in the video clip and sequential shots shooting modes, the field of view differs slightly (at a resolution of [640] in the video clip and sequential shots shooting modes, the field of view appears slightly zoomed in).

About sequential shots shooting

- In sequential shots shooting, the autofocus function is activated when the shutter release button is pressed and remains fixed at the same focus until the sequential shots are finished.

If the motion alert icon appears...

- During still image shooting, if the shutter speed is slow and the possibility that the image may be blurred due to camera movement becomes high, the motion alert icon  may appear on the LCD monitor. In this case, use a tripod to stabilize the camera when shooting, set the exposure control (see page 110) to [P], or set the flash operation mode to automatic (see page 73).

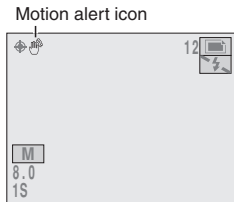



SHOOTING/RECORDING MODE SETTINGS

Before using the digital camera, you must first set the desired recording mode (still image, sequential shots, video clip, or audio recording).

- Still image shooting mode: For capturing still images.
 - Sequential shots shooting mode: For capturing several images in succession.
 - Video clip shooting mode: For capturing video clips.
 - Audio recording mode: For recording sound only.
 - PC camera mode: When using the camera as a PC camera.
-

1 Set the main switch to [] or [].

[] : To use the LCD monitor.

[] : To turn off the LCD monitor.

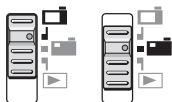



Main switch

2 Set the selector dial to the desired shooting mode.

For the still image mode, set to [].

For the sequential shots mode, set to [].

For the video clip shooting mode, set to [].

For the audio recording mode, set to [] (the Shooting Option Setting Screen will appear).

For the PC camera mode, set to [PC CAM].

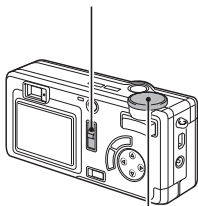

3 Press the power button.

- The camera turns on and the selected shooting mode is active.





Selector dial

CAPTURING STILL IMAGES

1 Set the camera to the still image shooting mode (see page 59).

2 Take a picture.

- ❶ Point the camera lens at the subject. Slowly press and hold the shutter release button halfway.
 - The area in the center of the LCD monitor comes clearly into focus, and the focus icon  appears in the upper left corner (focus-lock).
 - If the Shooting Setting Screen (see page 45) or Shooting Information Screen (see page 126) was displayed, it is exited.
 - The focus icon does not appear if the focus is set to telephoto  or manual [MF], or during quick shot shooting (see page 123).
- ❷ Press the shutter release button all the way.
 - The image is captured.

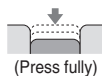
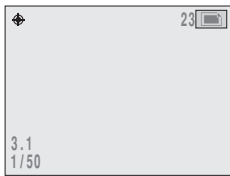
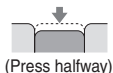

SEQUENTIAL SHOTS

This digital camera provides three types of sequential shots.

Standard sequential shots **[STD]**:

A normal sequential shot. (For the number of images captured, please see "Maximum number of sequential shots".)



AE shift sequential shots **[AE]**:

13 sequential images (or seven sequential images at resolution **[1600]** and compression **[FINE]**) are captured as the exposure (shutter speed) changes automatically.

Dark image (underexposed) → (Standard exposure) → Bright image (overexposed)

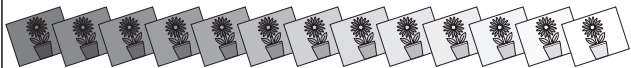

Best select shot **[BEST]**:

Four sequential images are captured from which you can select one to save.

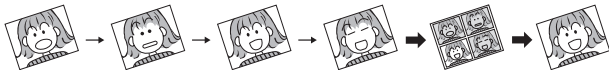

Select one to save.
The other three are deleted.

Maximum number of sequential shots

The maximum possible number of sequential shots depends on the resolution and compression rate settings.

Resolution	Compression rate	
	[FINE]	[NORM]
[1600]	8 images	15 images
[640]	50 images	50 images

Standard sequential shots **STD**

- 1 Set the camera to the sequential shots shooting mode (see page 39).

- 2 Select the standard sequential shots icon **STD** from the sequential shots mode menu, and press the SET button.

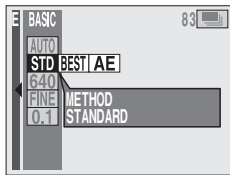

- 3 Select the desired frame interval from the sequential shots interval menu, and press the SET button.

- 0.2**: Images are captured at intervals of 0.2 second.
- 0.1**: Images are captured at intervals of 0.1 second.
- 0.06**: Images are captured at intervals of 0.06 second.
- 0.03**: Images are captured at intervals of 0.03 second (appears only when the resolution is set to **640**).

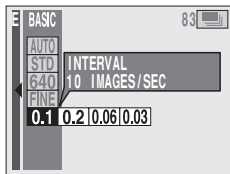

SEQUENTIAL SHOTS

4 Press the shutter release button to capture the sequential shots.

- Images are captured as long as the shutter release button is pressed.
- During shooting, **REC** appears in the LCD monitor.

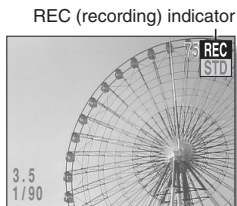

5 Finish capturing images.

- Release the shutter release button to end recording.

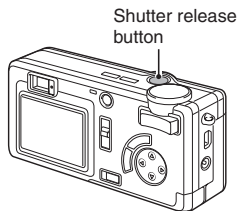

NOTE

- When shooting a picture at a resolution of **640** and sequential shots interval of **0.03** or **0.06**, the ISO sensitivity is automatically doubled, thus allowing you to capture a bright image without noise (Vertical Pixel Mixing [VP mix]). For this reason, the image quality may differ from the still images or images captured at a resolution of **640** and sequential shots interval of **0.2** or **0.1**.
- When the sequential shots interval **0.1** is selected, a rate of 7.5 images per second is effected, making the actual interval rate 0.1333... seconds. When the sequential shots interval **0.06** is selected, a rate of 15 images per second is effected, making the actual interval rate 0.0666... seconds.

AE shift sequential (auto bracket) shots **AE**

1 Set the camera to the sequential shots shooting mode (see page 39).

2 Select the AE shift sequential shots icon **AE** from the sequential shots mode menu, and press the SET button.

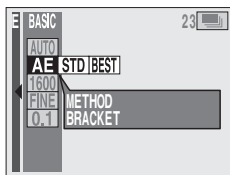

3 Select the desired frame interval from the sequential shots interval menu, and press the SET button.

- See step 3 on page 62.
-

4 Press the shutter release button to capture the sequential shots.

- When the shutter release button is pressed, sequential shots shooting begins.
- It is not necessary to keep the shutter release button depressed.
- During shooting, **REC** appears in the LCD monitor.
- After 13 sequential images are captured (seven images at resolution **1600** and compression **FINE**), shooting ends.

SEQUENTIAL SHOTS

Best select shot **BEST**

1 Set the camera to the sequential shots shooting mode (see page 39).

2 Select the best select shot icon **BEST** from the sequential shots mode menu, and press the SET button.

3 Select the desired frame interval from the sequential shots interval menu, and press the SET button.

- See step 3 on page 62.

4 Press the shutter release button to capture the sequential shots.

- When the shutter release button is pressed, sequential shots shooting begins.
- It is not necessary to keep the shutter release button depressed.
- During shooting, **REC** appears in the LCD monitor.
- After a few moments, the 4-image display appears showing the images captured.

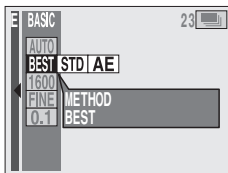

5 Select the image that you want to save.

- 1 Press the arrow button to move the orange frame to the image you want to save.
- 2 Press the SET button.
 - The Best Shot Confirmation Screen appears with the selected image displayed full screen. You can press [◀] or [▶] to select a different image.
 - To return to the 4-image display, select "EXIT", and press the SET button.

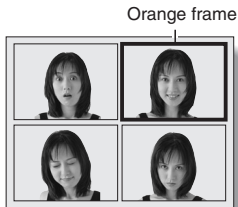

SEQUENTIAL SHOTS

6 Save the selected image and erase the others.

- 1 Make your final check of the image, and select “SAVE IMAGE ERASE OTHERS”.
- 2 Press the SET button.
 - A screen confirming whether or not you want to save the selected image and erase the others appears.
 - If you wish to return to the Best Shot Confirmation Screen, select “NO”, and press the SET button.
- 3 Select “YES”, and press the SET button.
 - “PROCESSING” appears for a few moments, and then the sequential shots shooting mode returns.
 - The selected image is saved in the still image folder; the other three images are deleted (nothing is saved in the sequential shots folder). The saved image can be played back in the still image playback mode.



<Best Shot Confirmation Screen>

Folder number and file name (image number)

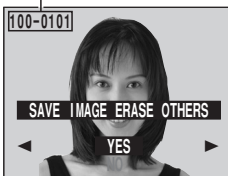

<Confirmation Screen for erasing the other images>

HINT

Capturing images without using the LCD monitor

- When taking pictures without using the LCD monitor, after the images are captured, the 4-image display (step 4) does not appear. All four images are saved in the sequential shots folder.

To save all four images

- While the 4-image display is shown in step 4, press the MENU button. All four images are saved in the sequential shots folder.

VIDEO CLIPS

When you shoot video clips, the sound is also recorded.

1 Set the camera to the video clip shooting mode (see page 59).

2 Press the shutter release button to record the video clip.

- It is not necessary to keep the shutter release button pressed while shooting.
 - During recording **REC** appears on the LCD monitor.
 - When the remaining recording time available for the currently recording clip becomes little, a countdown of the remaining recording time appears on the display.
-

REC (recording) indicator
Recording time (min:sec)
Remaining recording time (sec)



3 End the recording.

- Press the shutter release button to stop recording.
-

NOTE

- The data for a video clip is very large. Therefore, be aware that if the video clip is uploaded to a computer to be played back, the computer may not be able to play back the video fast enough, making it appear jerky. (The video will always be displayed properly on the LCD monitor or a television.)

AUDIO RECORDINGS

Your digital camera can record sound, just like a normal tape recorder.

1 Display the Shooting Option Setting Screen (see page 39).

- The audio recording icon  is highlighted.

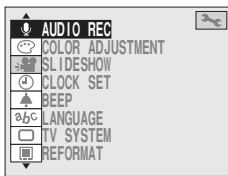

2 Press the SET button.

- The Audio Recording Screen appears.



3 Press [▼] on the arrow button to display the compression rate menu.

FINE: Low compression (high audio quality)

NORM: Normal compression (medium audio quality)

- Press [◀] or [▶] on the arrow button to select the desired compression rate setting, and press the SET button.

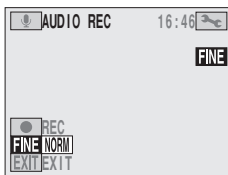

AUDIO RECORDINGS

- 4** Press [▲] or [▼] on the arrow button , and press the SET button.

- Recording begins. Point the microphone toward the sound you wish to record.
- **REC** (recording) appears on the LCD monitor during recording.

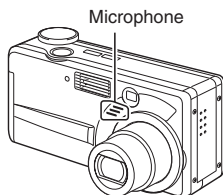

- 5** End the audio recording.

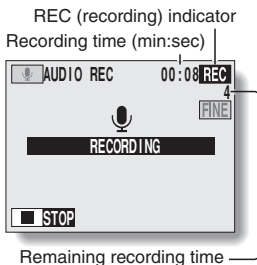

- Press the SET button once more to end the recording. You are returned to the Audio Recording Screen.
- When the remaining recording time becomes little, a countdown of the remaining recording time is shown.
- To return to the Shooting Option Setting Screen, in the Audio Recording Screen mode, press the MENU button, or select the **EXIT** icon and press the SET button.



HINT

- Each single recording can consist of up to 12 hours of recording time.

You can perform an audio recording even after turning off the Audio Recording Screen

- After displaying the Audio Recording Screen and  is selected (step 4), you can set the main switch to [] to put the digital camera into the audio recording standby mode. In this condition, just press the SET button to start recording. Or, after turning on the power to the digital camera, if you set the selector dial to [], even when the LCD monitor is off, you can press the SET button to start recording.

BASIC SHOOTING FUNCTIONS

Setting the focus

The focus setting can be changed depending on the distance to the subject.

1 Select the desired shooting mode (see page 59).

- If the Shooting Information Screen appears, press the MENU button to exit it.

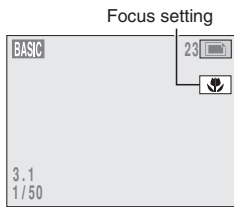

2 Press the focus button.

- The currently set focus setting is shown on the LCD monitor.
No icon: For photography at normal focus.



: For close-up photography (10 to 50 cm)



: For photography at distant focus (7 meters or more). Select this setting when you know the distance to your subject beforehand or when photographing a subject that is difficult to get into focus.



: The focus can be set to any distance from 10 cm to ∞ (manual focus). When manual focus is selected, the set distance is shown to the left of the **MF** icon.

<Example: Still image shooting mode>

3 Press the focus button to set the desired focus mode.

- Each time the focus button is pressed, the focus mode changes.
- If **MF** is selected, press [\blacktriangle] or [\blacktriangledown] on the arrow button to set the desired focus distance.

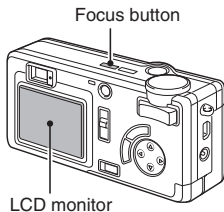

BASIC SHOOTING FUNCTIONS

4 Take the picture.

<Shooting without using the LCD monitor>

❶ Press the focus button.

- The LCD monitor turns on briefly to show the currently set focus mode.

❷ Press the focus button within 5 seconds to set the desired focus mode.

HINT

- The shortest distance for macro photography is 10 cm if [W] (Wide) on the zoom switch is pressed, and 40 cm if [T] (Tele) is pressed.
- In the manual focus mode, the shortest distance for taking pictures is 10 cm when [W] (Wide) on the zoom switch is pressed until it stops (wide angle), and 40 cm when [T] (Tele) is pressed until it stops (telephoto).
- The focus distance indication shows the distance between the lens surface and the subject.

Using the flash

The flash is used not only for taking pictures where there is insufficient light, but also when the subject is in shade or in backlight conditions. Your camera has four modes of operation (automatic flash mode, forced flash mode, flash off mode, and red-eye reduction mode). Flash photography is possible only in the still image shooting mode.

1 Set the camera to the still image shooting mode (see page 59).

2 Press the flash button.

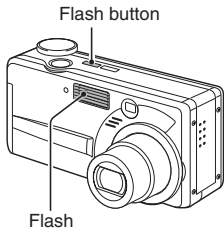

- The current flash mode is shown on the LCD monitor.



3 Press the flash button to select the flash mode.

- Each time the flash button is pressed, the flash mode icon changes.

No icon: The digital camera will detect the subject brightness and use the flash only when required. In a backlight situation, if only the center of the image is very dark, the flash will operate to compensate (auto flash).

- : The flash will operate with every image captured regardless of the conditions. Use this setting under backlight conditions, when the subject is in shade, under fluorescent lighting conditions, etc. (forced flash).
- : The flash will not operate even in dark situations. Use this setting when capturing an image in a location where flash photography is prohibited, or when shooting a night landscape scene (flash off).
- : The digital camera will detect the subject brightness and use the flash only when required. At this time the flash will operate in a manner that reduces the red reflection ("red-eye") in the subject's eyes.

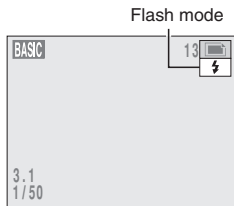

4 Press the shutter release button.

- The image is captured in the desired flash mode.

<Shooting without using the LCD monitor>

❶ Press the flash button.

- The LCD monitor turns on briefly to show the currently set flash mode.

❷ Press the flash button within 5 seconds to set the desired flash mode.

BASIC SHOOTING FUNCTIONS

HINT

- At normal focus, the effective flash range is 0.5 to 3.1 meters (widest lens setting) and 0.5 to 1.7 meters (telephoto lens setting). At macro focus, the effective flash range is 0.1 to 0.5 meters (widest lens setting) and 0.4 to 0.5 meters (telephoto lens setting).

NOTE

In the automatic flash mode...

- In the automatic flash mode using the LCD monitor, when the shutter release button is depressed halfway, a  icon appearing in the upper right area of the LCD monitor indicates that the flash will operate.

Shooting without using the LCD monitor

Compose the desired image by looking through the viewfinder. Compared to capturing images using the LCD monitor, this method uses less battery pack power.

1 Set the shooting mode (see page 59).

2 Set the main switch to [].

3 Look through the viewfinder and position the subject in the center.

4 Press the shutter release button.



Main switch

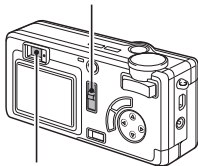

Viewfinder



Using the zoom

There are two zoom functions: optical zoom and digital zoom. You can specify whether or not the digital zoom can be activated when shooting. The digital zoom can be used when the resolution is set to **640** or less.

1 Make the zoom setting (see page 122), and point the camera lens at the subject.

2 Press [T] or [W] on the zoom switch to compose the desired image.

[T] : Zoom in on the subject.

[W] : Zoom out.

- When the zoom switch is pressed, the zoom bar appears on the LCD monitor.
- When the optical zoom factor becomes 3x, zooming stops temporarily. When [T] on the zoom switch is pressed again, the mode changes to the digital zoom mode and zooming continues (if digital zooming is enabled).

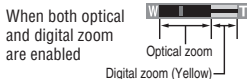
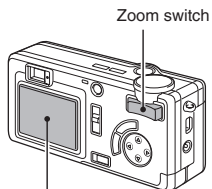

3 Press the shutter release button.

NOTE





- During video clip shooting, the optical zoom is disabled.
- The digital zoom cannot be used when you are shooting without using the LCD monitor.

BASIC MODE

Master the shooting functions in the basic mode.

Select the preset setting that matches your shooting conditions (Scene Select function)

You can select from various preset settings (aperture, shutter speed, etc.) for specific shooting conditions.

Preset settings			Features
Still image shooting mode	Sequential shots shooting mode	Video clip shooting mode	
Sports 			For shooting running and jumping, fast-moving subjects.
Portrait 			Perfect for shots with the subject at the center.
Night scene 	—	—	For amusement park and fireworks displays at night, produces a good balance between the bright lights and the dark background.
Wide-range 	—	—	For a wide-range shot. For shooting scenes with considerable contrast between light and dark.
Full auto 			The camera makes settings suitable for conditions.

-
- 1 Set to a shooting mode (see page 59), and display the Shooting Information Screen (see page 126).

- 2 Select the scene select menu.

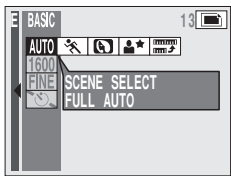

<Example: Still image shooting mode>

3 Select the desired icon, and press the SET button.

: Sports

: Portrait

: Night scene

: Wide-range shot

: The camera makes settings suitable for conditions (full auto).



NOTE

About the wide-range shot

In still image photography, two consecutive shots at different exposure settings are taken and then assimilated (wide-range shot). The result is an image with both smooth tones and low noise.

Please see “NOTE: About the wide-range shot” on page 103.

About other settings

- When setting a scene selection function, the following settings are fixed.
Exposure control:  Suitable program AE for each preset setting
ISO sensitivity: 
- When capturing images using the night scene  setting, use a tripod or other method to stabilize the camera.

To return to normal shooting

- Select  from the scene select menu, and press the SET button.

BASIC MODE

Setting the resolution

If the resolution is increased, the image quality will improve, but the remaining number of images that can be taken will decrease. Select the resolution according to the desired image quality and purpose.

- 1 Display a Shooting Setting Screen (see page 39).

- 2 Select the desired resolution from the resolution menu.

1600: 1,600 x 1,200 pixels

2000: 2,000 x 1,496 pixels

640: 640 x 480 pixels

320: 320 x 240 pixels

160: 160 x 120 pixels

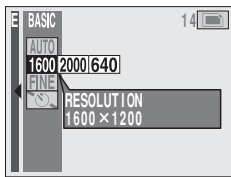

<Example: Still image shooting mode>

- The possible resolution settings for each shooting mode are as follows:

		Resolution (units: pixels) [Icon displayed on LCD monitor]				
		2,000 x 1,496 2000	1,600 x 1,200 1600	640 x 480 640	320 x 240 320	160 x 120 160
Shooting mode	Still image	Yes	Yes	Yes	Not available	Not available
	Sequential shot	Not available	Yes	Yes	Not available	Not available
	Video clip	Not available	Not available	Yes	Yes	Yes

- 3 Press the SET button.

- The selected resolution is set.

HINT

- The **2000** resolution is achieved by the camera processing the image internally to generate an approximately 30 million-pixel image.
-

NOTE

About the resolution and compression settings (see page 82)

- The image captured by a digital camera consists of a collection of small dots. The resolution refers to the number of these dots, and the greater the number, the higher the image quality. As the resolution increases, the size of the resulting data also increases, and the number of images that can be captured decreases. To compensate for this, this digital camera is able to compress the data. This digital camera uses JPEG compression. If JPEG compression is used, when the image is played back, an extremely small portion of it is lost. The higher the compression rate, the more of the original image is lost.

Therefore, this digital camera also allows you to store image data without any compression to ensure that none of the original image is lost. This is the **TIFF** mode. Since the image data is large when the **TIFF** mode is used, compared to JPEG compression, the digital camera requires more time both to store the data after the shutter release button is pressed and to display the image in the playback mode.

Using the self-timer

- 1** Display the Still Image Shooting Setting Screen (see page 39).
-

- 2** Select the self-timer on icon  from the self-timer menu.

: Turns off the self-timer function.

: Turns on the self-timer function.

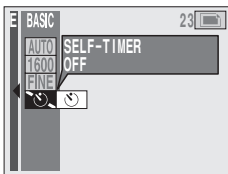

BASIC MODE

3 Press the SET button.

- This completes the self-timer setting.

4 Press the shutter release button.

- When the shutter release button is pressed, the self-timer indicator and standby indicator will light for about 7 seconds, flash for about 3 seconds, and then the image is captured.

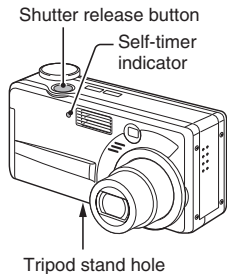

HINT

- If the shutter release button is pressed again before the image is captured, the self-timer mode is stopped temporarily. Press the shutter release button one more time to restart the self-timer.
- To cancel the self-timer mode, select the self-timer off icon  and press the SET button.
- If the operational sounds are set to on (see page 172), a warning tone (beep-beep-beep) sounds 3 seconds before the image is captured.

NOTE

- When using the self-timer function, be sure to use a tripod or place the digital camera on a level, stable surface.

Setting the compression rate

Use the procedure below to set the compression rate. Even if the same resolution is used, you can change the compression setting to decrease the image data size so that you can capture more images, or increase the image data size for no loss in image quality.

- 1 Display a Shooting Setting Screen (see page 39).**

- 2 Select the desired compression rate from the compression menu.**

- FINE**: Stores the data with a low compression (high quality).
- SFINE**: Stores the data with an extremely low compression (super high quality).
- NORM**: Stores the data with moderate compression (normal quality).
- TIFF**: Stores the data in TIFF format (no compression for highest quality).

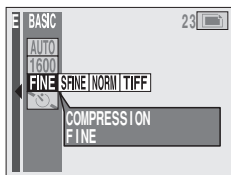

<Example: Still image shooting mode>

BASIC MODE

- The possible compression rate settings for each shooting mode are shown in the following table.

			Resolution (units: pixels) [Icon displayed on LCD monitor]				
			2,000 x 1,496 2000	1,600 x 1,200 1600	640 x 480 640	320 x 240 320	160 x 120 160
Shooting mode	Still image	SFINE	Not available	Yes	Not available	Not available	Not available
		FINE	Yes	Yes	Yes	Not available	Not available
		NORM	Yes	Yes	Yes	Not available	Not available
		TIFF	Not available	Yes	Not available	Not available	Not available
	Sequential shots	FINE	Not available	Yes	Yes	Not available	Not available
		NORM	Not available	Yes	Yes	Not available	Not available
	Video clip	FINE	Not available	Not available	Not available	Yes	Not available
		NORM	Not available	Not available	Yes	Yes	Yes

3 Press the SET button.

- The selected compression rate is set.

Setting the frame rate

The frame rate is the number of frames shot each second in a video clip. The higher the frame rate during recording, the smoother the video playback appears. However, a higher frame rate also requires a larger data size.

1 Display the Video Clip Shooting Setting Screen (see page 39).

2 Select frame rate from the frame rate menu.

15f: The video clip will be recorded at a rate of 15 frames per second.

30f: The video clip will be recorded at a rate of 30 frames per second.

3 Press the SET button.

- The selected frame rate is set.

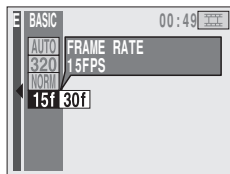

PLAYBACK MODE SETTINGS

This camera has playback modes for still images, sequential shots, video clips and audio recordings.

Still image playback mode:

For playing back still images and voice memos. Saved enlarged images (with the playback zoom) (see page 96) and copied images (see page 128) can also be viewed in the still image playback mode.

Sequential shots playback mode:

For viewing sequential shots images.

Video clip playback mode:

For viewing video clips.

Audio recording playback mode:

For listening to audio recordings.

1 Set the main switch to [▶].

2 Turn the selector dial to the desired playback mode.

- [📷]: Still image playback mode
 - [📺]: Sequential shots playback mode
 - [🎞️]: Video clip playback mode
 - [🔊]: Audio playback mode
- (The Playback Option Setting Screen appears.)

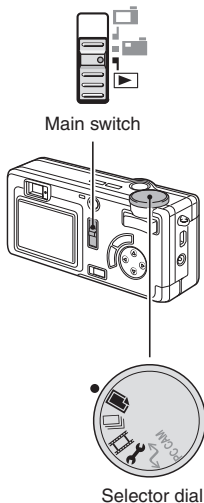

Playing back audio recordings

- 1 Turn the selector dial to [].
 - The Playback Option Setting Screen appears.

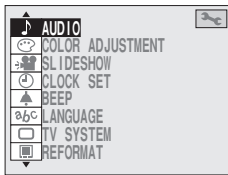

- 2 Select the audio playback icon [], and press the SET button.
 - The audio recording playback mode screen appears.
 - To continue the procedure, please see page 93.

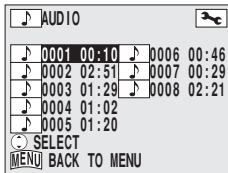

PLAYING BACK STILL IMAGES

Play back still images one by one

1 Select the still image playback mode (see page 85).

2 Press [◀] or [▶] on the arrow button.

To play back the previous image : Press [◀]

To play back the next image : Press [▶]

Play back a voice memo

- Display an image, and press the SET button. The voice memo is played back.
- Display the Still Image Playback Setting Screen (see page 39), select the volume icon , and press [◀] or [▶] on the arrow button to adjust the playback volume.

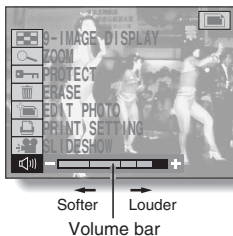

9-image display playback

1 Select the still image playback mode (see page 85).

2 Press [W] () on the zoom switch.

- The 9-image display appears.
- The number displayed on each image is its file name (image number).

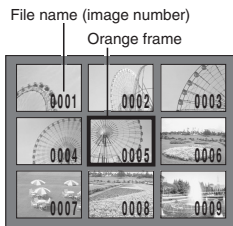

3 Use the arrow button to move the orange frame to the desired image, and press [T] ([]) on the zoom switch.

- The selected image is displayed full screen.
- Instead of pressing [T] ([]) on the zoom switch, you can also press the SET button to show the image full screen.

HINT

To jump forward or backward 100 images (if there are more than 100 images)

- ① Display the 9-image display playback screen.
- ② Press the flash button.
 - The frame around the images turns dark blue.
- ③ Press either [◀] or [▶] on the arrow button.
 - Press [◀] to move back 100 images.
 - Press [▶] to move forward 100 images.
 - The frame around the images returns to black.
 - To jump another 100 images, repeat steps ② and ③.
- ④ Use the arrow button to move the orange frame to the desired image, and press [T] ([]) on the zoom switch or the SET button.
 - The selected image is displayed full screen.

To access the 9-image display from the Playback Setting Screen...

- ① Display the Playback Setting Screen (see page 39).
- ② Select the 9-image display icon () , and press the SET button.

PLAYING BACK SEQUENTIAL SHOTS

1 Select the sequential shots playback mode (see page 85).

2 Press [◀] or [▶] on the arrow button.

To play back the previous image : Press [◀]

To play back the next image : Press [▶]

3 Press [W] ([) on the zoom switch.

- The 9-image display appears.
- The procedure from this point is the same as step 3 on page 88.
- When a voice memo has been added to an image, you can play it back by displaying the image and then pressing the SET button.
- To adjust the playback volume, display the Sequential Shots Playback Setting Screen (see page 39), select the volume icon [], and press [◀] or [▶] on the arrow button.

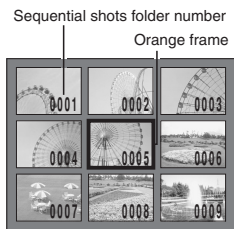

HINT

To change to a different sequential shots folder

- Perform step 3 above, and step 3 on page 88.

If the 9-image display appears in step 1

- Perform step 3 on page 88, and then return to step 2 above.

To quickly change to a different sequential shots folder

- In step 2, with the Playback Setting Screen or Playback Information Screen not displayed, press [▲] or [▼] to change to the previous or following sequential shots folder respectively.

To jump forward or backward 100 folders

- The procedure is the same as when playing back still images.

PLAYING BACK VIDEO CLIPS

1 Select the video clip playback mode (see page 85).

2 Play back the video clip.

Normal playback

- Press the SET button. If the Playback Setup Screen appears, press the SET button again to start playback.
- Pressing [◀] during a video clip playback will start reverse playback (the audio will not be heard).

To pause playback

- Press the SET button to pause playback; press the SET button again to continue playback.

To play back one image at a time

- While video clip playback is paused, you can press [▶] on the arrow button to view the frames in order, or [◀] to view them in reverse order.

To accelerate playback

- 2x fast forward playback: During normal speed playback, press [▶].
- 20x fast forward playback: During 2x playback, press [▶].
- Return to normal speed playback: During 20x playback, press [▶].
 - * Pressing [◀] will start reverse playback. The audio will not be heard.

To return to the beginning of the video clip

- To jump to the beginning of the video clip during playback: Press [▲].
- To jump to the end of the video clip during playback: Press [▼].
- To jump to the beginning of the next video clip: Pause playback, then press [▼].
- To jump to the beginning of the previous video clip: Pause playback, then press [▲].

To adjust the volume

- Display the Playback Setting Screen, select the volume icon , and press [◀] or [▶].
- To change to a different video clip, select a different video clip from the 9-image display.

<Example of button operations>

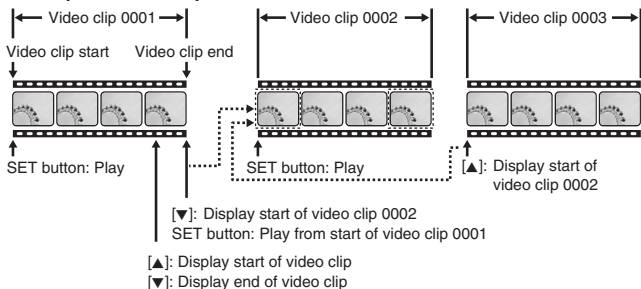

3 Press [W] ([]) on the zoom switch.

- The 9-image display appears.
- The procedure from this point is the same as step 3 on page 88.

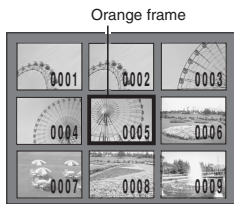

To jump forward or backward 100 video clips (if there are more than 100 video clips)

- With the 9-image display showing, follow these steps.
 - ① Press the flash button.
 - ② Press either [◀] or [▶].
- To jump another 100 video clips, repeat steps ① and ②.

HINT

To view video clips on your computer

- You can view video clips taken with this camera on your computer using QuickTime Ver. 3.0 or later from Apple.
- By using the QuickTime Plug-in included with QuickTime, you can also play back your video clips on your Internet browser.
- QuickTime5 for Windows and Macintosh is supplied with the included CD-ROM (Sanyo Software Pack).
- Online information about QuickTime can be found at <http://www.apple.com/quicktime/>.

LISTENING TO AUDIO RECORDINGS

- 1** Set the digital camera to the audio recording playback mode (see page 85).

- 2** Press [▲] or [▼] on the arrow button to select the desired audio recording, and press the SET button.

- The Audio Recording Playback Screen for the selected audio recording appears.

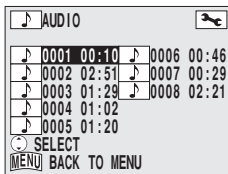



- 3** Select the audio playback icon , and press the SET button.

- Playback starts.

To pause playback

- Press the SET button to interrupt playback; press it again to continue playback.

To fast forward or rewind

- Fast forward: During playback, press .
- Rewind: During playback, press .
* The audio will not be heard.
- If  is pressed during fast forward or rewind, playback will start.

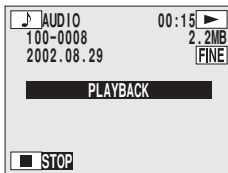
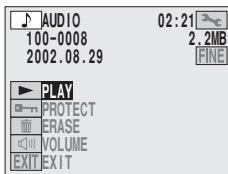

To adjust the volume

- ① On the Audio Recording Playback Screen, select the volume icon .
- ② Press [◀] or [▶] to adjust the volume.

To select a different audio recording

- On the Audio Recording Playback Screen, press the MENU button. The Audio Recording Select Screen appears; select the desired audio recording and play it back.

To stop playback

- During playback, press the SET button. Playback will stop, and you are returned to the Audio Recording Playback Screen.

USING THE VARIOUS PLAYBACK FUNCTIONS

Automatic playback (slideshow)

Still images and video clips can be automatically played back in a slideshow fashion. If voice memos are attached, they are also played back at the same time.

1 Display the Playback Option Setting Screen (see page 39).

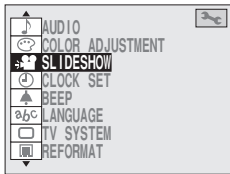

2 Select the slideshow icon , and press the SET button.

- The Slideshow Screen appears.
- Select "TIME", press the SET button, and press [▲] or [▼] on the arrow button to select the time that each image is shown. Select 1 sec., 4 sec., 7 sec. or 10 sec.
- If the time is set to 1 sec., voice memos will not be played back.

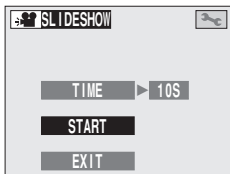

3 Press the SET button.

4 Select "START", and press the SET button.

- Slideshow playback begins.
- The still images or video clips are played back in the order in which they were recorded.
- To interrupt the slideshow, press the MENU button, the SET button, or an arrow button.

HINT

- The slideshow automatically stops after 12 hours of uninterrupted playback.

To play back only still images in a slideshow

- ① Display the Still Image Playback Setting Screen.
- ② Select the slideshow icon , and press the SET button.
 - The slideshow image appears. The rest of the procedure is the same as steps 2 to 4 on page 95.

Magnifying (zooming in) the image

The saved images can be magnified for viewing during playback.

1 Display the image that you want to magnify.

- For a video clip, pause playback at the place you wish to magnify.
-

2 Press [T] ([]) on the zoom switch.

- Magnification is enabled.
- The image is magnified, and the central portion of the image is displayed.
- You can use the arrow button to view different parts of the magnified image.



3 Magnify the image further.

To magnify:

Press [T] ([]) on the zoom switch.

To return to normal size:

Press [W] ([]) part on zoom switch.



USING THE VARIOUS PLAYBACK FUNCTIONS

HINT



- The maximum degree of magnification will depend on the resolution of the original image.
- The maximum magnification for **2000** resolution is about 31 times.
- If the image has been rotated, it will be returned to its original orientation and then enlarged.
- One scene (still image) of a paused video clip can be enlarged; however, a video clip cannot be played while enlarged.

HINT

The magnified portion of the image can be saved as a separate image.

- Press the shutter release button. The magnified portion is saved as a new still image.

To magnify the image from the Playback Setting Screen

- ① Display the Playback Setting Screen (see page 39).
- ② Select the zoom icon , and press the SET button.
 - After the screen in step 2 on page 96 appears, you can magnify the image further by pressing [T] () on the zoom switch.

Rotating an image

Captured images can be rotated to the correct orientation for viewing.

1 Display the still or sequential shots image you wish to rotate.

2 Display the Playback Setting Screen (see page 39).



3 Select the edit photo icon  (or ) , and press the SET button.

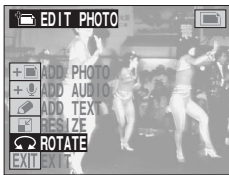

- The Edit Photo Screen appears.



<Example: Still Image Playback Mode>

4 Select the rotate image icon , and press the SET button.

- The Rotate Image Screen appears.
- : Rotates image clockwise 90 degrees
- : Rotates image counterclockwise 90 degrees

5 Select the rotate right icon  or rotate left icon , and press the SET button.

- Each time the SET button is pressed, the image is rotated 90 degrees.



USING THE VARIOUS PLAYBACK FUNCTIONS

Playing back images on a TV set

By connecting the digital camera to a television set, you can view the captured images on the TV screen.

Connections

Connect the supplied AV cable from the DIGITAL/AV terminal on the digital camera to the AUDIO and VIDEO input terminals on the TV.

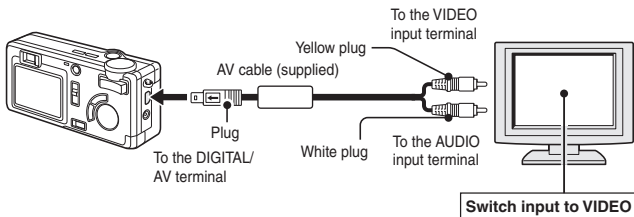

* If the dedicated AV cable is unplugged/plugged in, the Playback Setting Screen is canceled.

Playback

- After connecting the digital camera to the television, set the TV input switch to VIDEO input.
- The playback method is the same as when viewing images on the LCD monitor.
- When an AV cable is connected, the LCD monitor display appears smaller than usual.
- If the TV system setting is set to PAL, no image appears on the camera's LCD monitor.
- The same playback procedure as when playing back with the camera is used to play back voice memos and audio recordings as well.
- The sound output from the digital camera is monaural.

Voice memo playback: see page 87

Audio recording playback: see page 93

CAUTION

- Do not use excessive force when connecting and disconnecting cables.

DISPLAYING IMAGE INFORMATION (PLAYBACK INFO SCREEN)

On the Information Screen you can check what the settings were when an image was captured.

1 Display the desired image.

2 Press the MENU button for at least 1 second.

- The Playback Information Screen appears.
- If the MENU button is pressed again, the Playback Information Screen is exited.

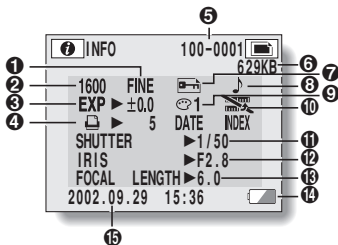

<Still image playback mode>

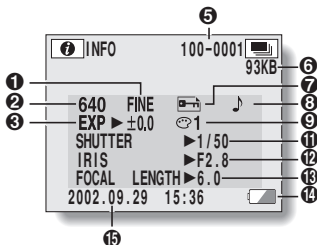

<Sequential shots playback mode>

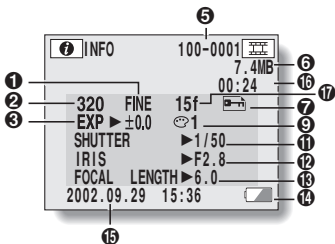

<Video clip playback mode>

- ❶ Compression rate
- ❷ Resolution
- ❸ Exposure correction value
- ❹ Print settings (still image playback mode only)
- ❺ Location of data (folder number) and file name
- ❻ Data size
- ❼ Protect setting
- ❽ Voice memo indicator (still image and sequential shots playback modes only)
- ❾ Color correction setting
- ❿ Wide-range shot setting (still image playback mode only)
- ⓫ Shutter speed
- ⓬ Aperture
- ⓭ Focus distance
- ⓮ Remaining battery pack charge
- ⓯ Date and time of image
- ⓰ Playback time (video clip playback mode only)
- ⓱ Frame rate (video clip playback mode only)

HINT

- You can display the file name (image number) by pressing the flash button while an image is being played back.

WIDE-RANGE SHOT

With this feature, when the shutter release button is pressed, two consecutive shots are taken at different exposure settings, and they are then automatically assimilated into one image. This produces an image with the smooth tone characteristics of the light areas and low-noise characteristics of the dark areas.

1 Display the Shooting Setting Screen (see page 39).

2 Select the wide-range shot on icon from the wide-range menu, and press the SET button.

: For normal photography (wide-range shot off).

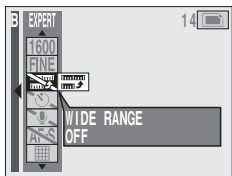

: For photography using wide-range shot (wide-range shot on).



3 Press the shutter release button.

NOTE

About the wide-range shot

- When wide-range shot on is selected, the exposure control setting is automatically set to , the flash operation mode to , the digital zoom setting to off, and the quick shot setting to . In addition, when the wide-range shot on setting is canceled, these modes are all restored to their previous settings.
- If the subject is too light or too dark, the wide-range shot may not be effective.
- Because of the long exposure time compared to normal photography, care should be taken to keep the camera steady when shooting (see page 58).
- If you shoot a wide-shot photos in which the smear phenomenon or flare phenomenon, etc. appears, or when there is fog, the result may be an unnatural photo due to a visible unevenness in the image.

ADDING A VOICE MEMO

In the still image shooting mode, you can record approximately 4 seconds of sound (called a “voice memo”) when capturing the image.

1 Display the Still Image Shooting Setting Screen (see page 39).

2 Select the add voice memo icon from the voice memo menu, and press the SET button.

: For no voice memo.

: For adding a voice memo.

3 Press the shutter release button to capture the image, and then talk into the microphone.

- About 4 seconds of sound are recorded.
- During recording, **REC** appears in the upper right area of the LCD monitor.
- After recording has finished, the add voice memo setting reverts off.

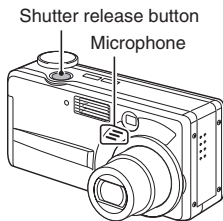
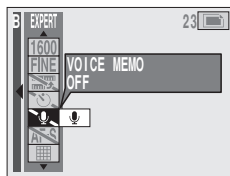

HINT

- When the compression rate is set to **TIFF**, it takes approximately 10 seconds for the image data to be recorded (when using a CompactFlash card), after which voice memo recording will start.
- Each voice memo uses one-half the memory of an image captured at **640** resolution and **NORM** compression rate.
- The voice memo can be played back in the still image playback mode (see pages 85, 87).

SETTING THE FOCUS MODE

You can choose from the following 2 types of autofocus:

Multi-section focus: The distance to the subject is detected by sampling from multiple areas of the entire shooting screen.

Spot focus: The camera focuses on the subject in the center of the LCD monitor.

1 Display the Shooting Setting Screen (see page 39).

2 Select a focus method from the spot focus menu, and press the SET button.

: Multi-section focus is selected.

: Spot focus is selected.

- This completes the focus method setting.
- When the spot focus setting is selected, the focus mark + appears in the center of the LCD monitor.

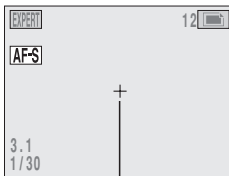
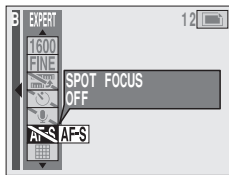

Focus mark

NOTE

When the spot focus setting is selected

- To focus on a specific object, point the camera so that the object matches the focus mark in the center of the LCD monitor, and press the shutter release button halfway. The camera will focus on the subject at the focus mark in the center of the LCD monitor. In this condition, compose the picture and press the shutter release button all the way down to capture the image.
- It may be difficult to focus if there is little contrast in the subject or if the subject is very small.

LIGHT-MEASURING MODE SETTING

You can select from 3 types of light-measuring modes.



Multi-section light-measuring : Light is measured by sampling from multiple areas of the entire shooting screen.

Center-weighted light-measuring : Light is measured from the entire shooting screen, but gives more importance to the values near the center.

Spot light-measuring : You can compose the picture and capture the image after first measuring the light only at the center spot of the LCD monitor.

1 Display a Shooting Setting Screen (see page 39).

2 Select a light-measuring mode from the light-measuring mode (EXP MEASURE) menu.

-  : Multi-section light-measuring
-  : Center light-measuring
-  : Spot light-measuring

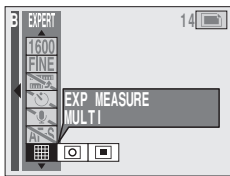

3 Press the SET button

- This completes the light-measuring mode setting.
- When spot light-measuring is selected, the light-measuring spot mark  appears in the center of the LCD monitor.

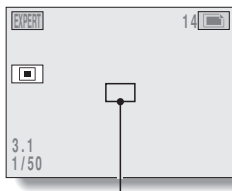

Light-measuring spot mark

HINT

Shooting with the spot light-measuring mode

- Point the camera so that the light-measuring spot mark is centered on the specific spot you wish to use to measure the light, and press the shutter release button halfway. The light at the spot mark will be measured. Keeping the shutter release button depressed halfway, compose the picture and press the shutter release button all the way down to capture the image.

WHITE BALANCE SETTING

This digital camera automatically adjusts the white balance under most lighting conditions. However, if you want to specify the lighting conditions or change the overall tone of the image, the white balance can be manually set.

1 Display a Shooting Setting Screen (see page 39).

2 Select a white balance setting from the white balance menu.

AWB: The digital camera will make the white balance adjustment automatically based on the natural and artificial light conditions. This is the setting used in the auto mode.

: For shooting outside on a sunny day.

: For shooting outside on a cloudy day.



: For shooting inside under fluorescent lighting.

: For shooting inside under incandescent lighting.

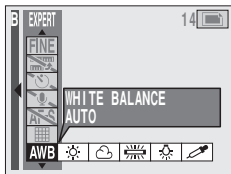





: For more accurate adjustment or when the light source cannot be specified.



Setting procedure

- 1 Select the  icon and press the SET button.
 - The  icon moves to the left end of the line.
 - 2 Fill the entire screen with a plain white card (or piece of paper, etc.), and perform step 3.
-

3 Press the SET button.

- This completes the white balance setting.
 - Once the white balance setting is programmed for the  icon, it is retained even if another white balance setting (, , , , or ) is selected. If you changed to another setting, whenever you select the  icon and press the SET button, the previously programmed setting is recalled.
-

HINT

To cancel the white balance setting

- Perform step 2, select , and then press the SET button.
-

NOTE

To capture sepia-tone images

- In step 2 of step 2, instead of using a white card, use a blue card to set the white balance. You can experiment and get different results by changing the card color to program the white balance.

ISO SENSITIVITY SETTING

With the initial settings, the ISO sensitivity is automatically set according to the brightness of the subject. However, the ISO sensitivity can be fixed at the equivalent of 100, 200, or 400.

- 1 Display a Shooting Setting Screen (see page 39).**
-

- 2 Select an ISO sensitivity setting from the ISO sensitivity menu.**

- [ISO-A]**: Sets the ISO sensitivity automatically (equivalent to ISO100 to 200).
- [100]**: Sets the sensitivity to ISO100 equivalent.
- [200]**: Sets the sensitivity to ISO200 equivalent.
- [400]**: Sets the sensitivity to ISO400 equivalent.

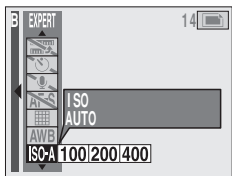

- 3 Press the SET button.**

- This completes the ISO sensitivity setting.
-

HINT

- By setting a higher ISO sensitivity, you can set higher shutter speeds and capture images in darker locations, but noise in the captured images may increase.
- The Vertical Pixel Mixing (VP mix) is active, producing bright images with little noise, in the following cases:

When shooting a video clip: All settings

When shooting sequential shots: At resolution **[640]** with a sequential shot interval setting of **[0.03]** or **[0.06]**

SETTING THE EXPOSURE CONTROL

By setting the shutter speed and aperture size, various exposure controls are possible. By changing the settings in accordance with the scene to be photographed, you can create the image that you want to express. The exposure control can be set in the still image shooting mode and sequential shots shooting mode.

1 Display the Still Image or Sequential Shots Shooting Setting Screen (see page 39).

2 Select an exposure control mode from the exposure control menu.

- P**: The optimum shutter speed and aperture size are set according to the brightness of the subject. (Aperture and shutter variable program AE)

Example: For simple shooting with minimum setup, using the camera's automatic settings.

- A**: This allows you to set a specific aperture size. The camera automatically sets an appropriate shutter speed based on this setting. (Aperture priority AE)

Example: To open the aperture for portraits with a blurred background (for a shallow field depth), or to close the aperture for a clear foreground and background (for a deep field depth).

- S**: This allows you to set a specific shutter speed. The camera automatically sets an appropriate aperture size based on this setting. (Shutter speed priority AE)

Example: To set a fast shutter speed for capturing a clear image of a fast-moving object, or to set a slow shutter speed to shoot the flow of a background scene.

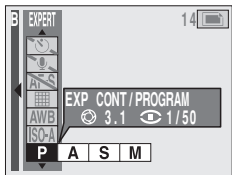

SETTING THE EXPOSURE CONTROL

[M]: This allows you to set a specific shutter speed and aperture size.
(Manual exposure control)

Example: When shooting in a dark location without using the flash, set the shutter to stay open for a longer time (slow shutter). When used for shooting nighttime scenes, you can capture lights flowing across the image.

3 Press the SET button.

- The screen corresponding to the exposure control mode selected in step 2 appears.

<Aperture and shutter variable program AE [P]>

- The setting changes to aperture and shutter variable program AE, and you are returned to the Shooting Setting Screen.

<Aperture priority AE [A]>

- The display to set the aperture size appears.
- Press [▲] or [▼] on the arrow button to set the desired aperture size.

Tele: 4.9 to 11.8

Wide: 2.7 to 6.7

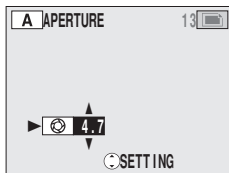



<Shutter speed priority AE [S]>

- The display to set the shutter speed appears.
- Press [▲] or [▼] on the arrow button to set the desired shutter speed.

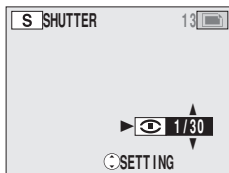
Setting range: 16 sec. to 1/2500 sec.



<Manual exposure control [M]>

- The display to set the aperture size and shutter speed appears.
- Press [◀] or [▶] on the arrow button to select aperture size  or shutter speed , and press [▲] or [▼] on the arrow button to change the setting.

Setting range:

Aperture : 4.9 to 11.8 (Tele)
2.7 to 6.7 (Wide)

Shutter speed : 16 sec. to
1/2500 sec.

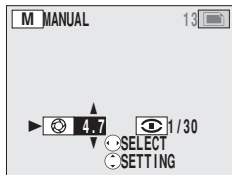

4 Press the SET button.

- This completes the exposure control setting.
- You are returned to the Shooting Setting Screen.

HINT

- When using a slow shutter setting, use a tripod or the like to stabilize the digital camera.
- When manual exposure control is selected, the exposure correction value becomes ± 0 and exposure correction cannot be performed.
- If the aperture value is set to F10 or higher, the resolution of the shot picture may be slightly reduced.

CAUTION

- While the Exposure Control Setting Screen is displayed (step 3), the zoom function is disabled.

ADJUSTING THE COLOR TONES (REAL-COLOR EQUALIZER)

You can adjust the color tones (hue, saturation and brightness) of the captured images. In addition to adjusting the tones with the camera's settings, you can also download data settings created on your computer for color tone correction.

Adjust the color tones with the digital camera



1 Display the Shooting Option Setting Screen (see page 39).

2 Select the color adjustment icon , and press the SET button.

- The Color Adjustment Screen appears.
- The highlighted icon indicates the current setting.

 to :

Set the color tone adjustment (color adjustment on). Data for 6-color-mode settings created on a computer can also be downloaded.

 to :

Select from these when downloading data for 12-color-mode settings created on a computer (see page 119).



DEF: Initial color settings (color adjustment off).

EXIT: Return to the Shooting Option Setting Screen.

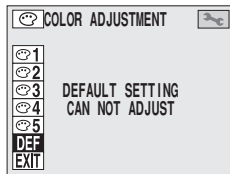
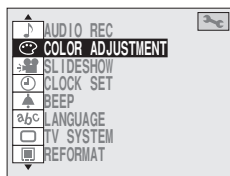
- After pressing the SET button, if the setting data download screen appears, select NO, and press the SET button; the Color Adjustment Screen will then appear.



3 Select one from the to icons, and press the SET button.

- Selecting one of the  to  icons allows confirmation of their respective setting values. Pressing the SET button displays the screen for the hue, saturation and brightness settings.

R: Set the red hue, saturation and brightness.

Y: Set the yellow, and saturation and brightness.

G: Set the green hue, saturation and brightness.





C: Set the cyan hue, saturation and brightness.

B: Set the blue hue, saturation and brightness.

M: Set the magenta hue, saturation and brightness.

OK: The hue, saturation and brightness settings are completed, and you are returned to the Color Adjustment Screen.

EXIT: The new settings are canceled, and you are returned to the Color Adjustment Screen.

COLOR ADJUSTMENT		HUE	SAT	BR
 1				
 2	R	00	00	00
 3	Y	00	00	00
 4	G	00	00	00
 5	C	00	00	00
DEF	B	00	00	00
EXIT	M	00	00	00

		HUE	SAT	BR
 1	OK			
	R	00	00	00
	Y	00	00	00
	G	00	00	00
	C	00	00	00
	B	00	00	00
	M	00	00	00
	EXIT			

ADJUSTING THE COLOR TONES (REAL-COLOR EQUALIZER)

4 Adjust the color.

- 1 Press [▲] or [▼] on the arrow button to select a color icon ([R] to [M]) to adjust.
- 2 Press [◀] or [▶] to select the color property you wish to change (hue, saturation or brightness).
- 3 Press [▲] or [▼] to adjust the value of the selected color property.
 - Adjust the hue while watching on the LCD monitor.
 - Each property can be set within a maximum range of +50 to -50.
- 4 Press the SET button.
 - To change the settings for other colors, press [▲] or [▼] to select another color, and then repeat steps 2 to 4.

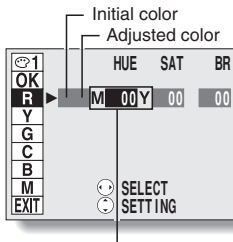

The characters to the left and right of the hue setting value indicate the color change. In this example, the indicated setting changes magenta to red hues ([Y]).
When set to a - value, magenta changes to blue hues ([M]).

5 Select the [OK] icon, and press the SET button.

- The screen to input a title appears.
- If you are correcting a color that was previously corrected, the set name will appear.
- A maximum of 10 characters can be input for the title. (For entering text, please follow procedures 6 through 8 on pages 132 and 133.)

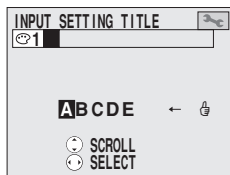

6 Select the mark, and press the SET button.

- This completes the color adjustment setting.
- You are returned to the Shooting Option Setting Screen.
- You can display and confirm the color adjustment setting on the shooting status display (see page 51) and Shooting Information Screen (see page 127).

NOTE

About the hue setting

- The hue setting is shown for each separate color—red, yellow, green, blue, etc. The hue can be set within a maximum range of +50 to -50. But the actual range that can be set is limited depending on the other hue settings of a corrected color.

Example: If the **[M]** hue is set to +20, the - side range for the **[R]** hue setting goes up to only -30.

About the saturation setting



- The saturation setting specifies the degree of color brilliance. When the saturation setting is set to the + side, the colors are more vivid; on the - side they are more smoky. When set to -50, the color has no saturation and it becomes monochrome.

About the brightness setting



- The brightness setting specifies the degree of lightness or darkness. When the brightness setting is set to the + side, the image is lighter; on the - side it is darker.





ADJUSTING THE COLOR TONES (REAL-COLOR EQUALIZER)

Example of hue and saturation settings

Monochrome photography	Set saturation and brightness values for all colors from R to M to -50 ( initial settings).
To set all colors except red to monochrome	Set saturation and brightness values for colors Y to M to -50 ( initial settings).
For a brilliant blue sky	Set C and B saturation values to the + side.
To emphasize the greenness of trees and plants	Set G hue and saturation values to the + side.

About color correction with Real Color Equalizer 3.0 on PC

- If the Real Color Equalizer 3.0 on PC application (in the provided CD-ROM [Sanyo Software Pack]) is used to change the colors (see page 120) and results in extreme values for the camera's color settings, accurate color adjustment may not be possible. It is recommended that when adjusting the colors using the Real Color Equalizer 3.0 on PC you set the camera's color adjustment setting to **DEF** (initial settings), or set the hue and saturation values close to 0 and photograph the images without extreme settings.
- Setting data is prestored in color adjustment icons  to . After overwriting these settings with your custom settings, you can reset the settings to their original values by loading them from the provided CD-ROM (Sanyo Software Pack). The settings data is in the Setting data folder within the Real Color Equalizer folder.

Icon	Title	Settings data file name	To photograph
	(None)	sancam01.cfg	Color tone adjustment off
	MONOCHROME	sancam02.cfg	Monochrome
	RED	sancam03.cfg	Red only generated
	MOUNTAIN	sancam04.cfg	Mountain scenes, etc.
	SEA	sancam05.cfg	Marine scenes, etc.

ADJUSTING THE COLOR TONES (REAL-COLOR EQUALIZER)

Download the color tone correction data created on a computer

The settings data created using the Real Color Equalizer 3.0 on PC in the supplied CD-ROM (Sanyo Software Pack) can be downloaded to your digital camera.

- 1** Insert a CompactFlash, on which color tone correction data created on a computer was saved, into the digital camera.
 - 2** Display the Shooting Option Setting Screen (see page 39).
-

- 3** Select the color adjustment icon , and press the SET button.
 - The Download Settings Data Screen appears.

YES : Download the settings data created on a personal computer.

NO : Use the camera settings for color tone correction.
-

- 4** Select “YES”, and press the SET button.
 - The list of settings data saved on the CompactFlash appears.

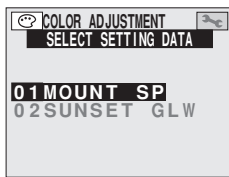
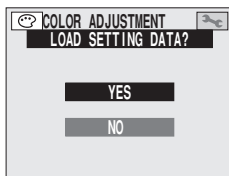

-
- 5** Press [▼] or [▲] on the arrow button to select the desired settings data, and press the SET button.

- The Select Where To Save Screen appears.

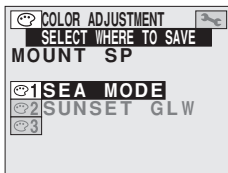

-
- 6** Press [▼] or [▲] on the arrow button to select the icon in which to save the settings data.

For 6-color mode setting data:

Select one from [1] to [3].

For 12-color mode setting data:

Select [4] or [5].

-
- 7** Press the SET button.

- The settings data created on the computer is stored to the icon selected in step 6, and the actual settings are shown on the Color Tone Adjustment Screen.
- When the SET button is pressed again, the color adjustment is set, and you are returned to the Shooting Option Setting Screen.



NOTE

About the Real Color Equalizer 3.0 on PC

- By using the Real Color Equalizer 3.0 on PC that comes in the supplied CD-ROM (Sanyo Software Pack), you can perform the color adjustment on your computer. In addition to the 6-color mode, the color adjustment settings for 12 colors are also possible. Moreover, the color adjustment of hue, saturation and brightness settings data that is created using the Real Color Equalizer 3.0 on PC's 6-color mode can be performed using the digital camera. For details about using the Real Color Equalizer 3.0 on PC, see the instruction manual accompanying the Sanyo Software Pack.

ADJUSTING THE COLOR TONES (REAL-COLOR EQUALIZER)

To select previously set color correction settings

Imagining various scenes, you can store suitable color correction settings in each of the icons  to  beforehand. You can then select the icon suitable for the scene you are photographing to quickly change to the optimum color correction settings.

1 Display a Shooting Setting Screen.

2 From the color correction menu, select the icon in which you stored the color adjustment settings, and press the SET button.

- To return to the initial color correction settings, select the **DEF** icon, and press the SET button.

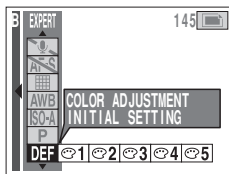



DIGITAL ZOOM SETTING

This setting allows you to specify whether or not the digital zoom is enabled during zoom shooting (see page 76) at a resolution of **640** or lower.

1 Display a Shooting Setting Screen (see page 39).

2 Select a digital zoom setting from the digital zoom menu.

: Digital zoom cannot be used.

: Digital zoom can be used.

3 Press the SET button.

- This completes the digital zoom setting.

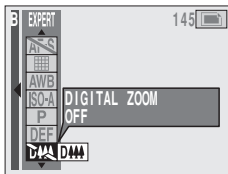



QUICK SHOT SETTING

(STILL IMAGE SHOOTING MODE ONLY)

With the initial settings, when the shutter release button is pressed, the digital camera performs the exposure correction, the white balance settings, the focussing, and other settings before the image is captured. This results in a delay after the shutter release button is pressed before the image is actually captured. By turning on the quick shot setting, these settings are set less precisely, but the delay after the shutter release button is pressed until the image is actually captured is drastically reduced.

1 Display the Still Image Shooting Setting Screen (see page 39).

2 Select a quick shot setting from the quick shot menu.

- : Turns off the quick shot setting.
- : Turns on the quick shot setting.

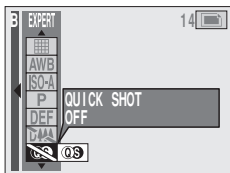

3 Press the SET button.

- This completes the quick shot setting.

HINT

How to use the quick shot

- ① Select  to turn on the quick shot setting.
- ② Press the shutter release button, and when the camera is ready to shoot, press it again.
 - The first time the shutter release button is pressed, the digital camera performs the normal settings; the second time it is pressed, quick shot shooting is enabled. If the shutter release button is subsequently pressed within 1 second, consecutive quick shots are possible. After an interval of one second or more, however, the camera returns to normal shooting.

EXPOSURE CORRECTION

When capturing images, you can make the image lighter or darker.

1 Exit the Shooting Setting Screen (or Shooting Information Screen).

- Press the MENU button to exit the Shooting Setting Screen (or Shooting Information Screen).
-

2 Press [◀] or [▶] on the arrow button.

- The exposure correction bar appears.
- At this point, you can press [◀] or [▶] on the arrow button to adjust the exposure.

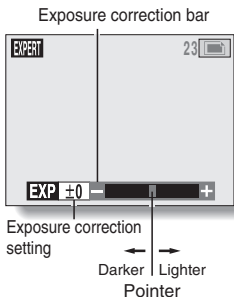

HINT

- The exposure correction setting is canceled in the following cases.
 - When the pointer is set to the center position
 - After the main switch or selector dial is moved
 - After the power is turned off.
- The exposure setting numerical value is shown at the left end of the exposure bar. The exposure can be set to a value from -1.8EV to $+1.8\text{EV}$.
- While exposure correction is active, the standby indicator in the viewfinder flashes green.

Shortcut for setting the exposure correction

- From a Shooting Setting Screen or Information Screen...
 - 1 In the EXPERT mode, select the exposure correction icon **EXP** from the Shooting Setting Screen.
 - 2 Press [◀] or [▶] on the arrow button.
-

CAUTION



- Exposure correction is not possible in the AE shift sequential shots mode.

FLICKER-REDUCTION SETTING (VIDEO CLIP SHOOTING ONLY)

The flicker-reduction setting reduces the flicker that results when filming video clips under fluorescent lights and the like where the background lighting pulsates at the frequency of the power supply. The flicker-reduction setting is set for a frequency of 50 Hz.

1 Display the Video Clip Shooting Setting Screen (see page 39).

2 Select a flicker-reduction setting from the flicker-reduction setting menu.

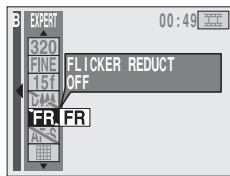

- : Turns off the flicker-reduction setting.
- : Turns on the flicker-reduction setting.



3 Press the SET button.

- This completes the flicker-reduction setting.

HINT

- Note that although the flicker-reduction setting decreases the image flicker that occurs under fluorescent lighting, the image quality may deteriorate slightly.
- If the flicker-reduction setting is used outdoors on a very bright day, a halation effect may occur.
- If the flicker-reduction is set to , then the ISO sensitivity setting (see page 109) becomes fixed at .

SHOOTING SETTING INFORMATION DISPLAY (SHOOTING INFO SCREEN)

This Information Screen allows you to check the current settings while shooting.

Display the Shooting Information Screen

- 1 Put the digital camera in the shooting status.
- 2 Press the **MENU** button for at least 1 second.
 - The Shooting Information Screen appears.
 - To exit the Information Screen, press the MENU button again.

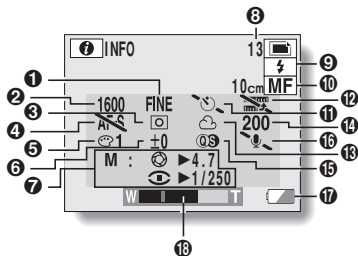

<Still image shooting mode>

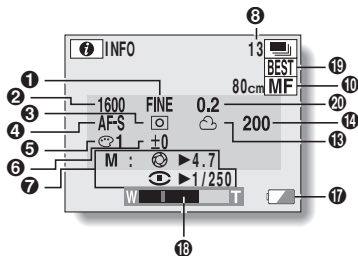

<Sequential shots shooting mode>

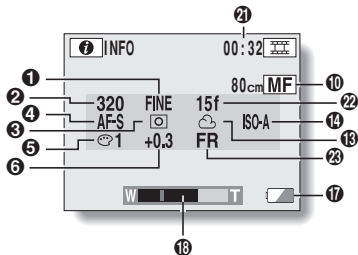

<Video clip shooting mode>

- | | |
|----------------------------------|--|
| ① Compression rate* | ⑭ ISO sensitivity setting |
| ② Resolution* | ⑮ Quick Shot setting |
| ③ Light-measuring mode setting | ⑯ Voice memo setting |
| ④ Spot focus setting | ⑰ Remaining battery pack charge indication |
| ⑤ Color tone correction setting | ⑱ Zoom bar |
| ⑥ Exposure correction setting | ⑲ Sequential shots mode setting* |
| ⑦ Exposure control setting | ⑳ Sequential shots interval setting* |
| ⑧ Number of images remaining* | ㉑ Remaining shooting time |
| ⑨ Flash setting* | ㉒ Frame rate setting* |
| ⑩ Focus setting* | ㉓ Flicker-reduction setting |
| ⑪ Self-timer setting* | |
| ⑫ Scene select function setting* | |
| ⑬ White balance setting | |

* In the BASIC mode, only icons indicated by the [*] mark are shown.
All the icons never appear at the same time.

Exit the Shooting Information Screen

<When using the LCD monitor>

- Press the MENU button.

<When not using the LCD monitor>

- Press the MENU button, or wait 5 seconds.

COPYING IMAGES

You can select one image from a sequential shots sequence or one image (scene) from a video clip, copy it, and save it as a still image (the original data remains unchanged).

1 Display the desired image from a sequential shots sequence or video clip.

2 Display the Playback Setting Screen (see page 39).

3 Select the copy icon , and press the SET button.

- The Copy Screen appears with “YES” selected.

YES: The image is copied and saved as a still image (the original data is left unchanged).

EXIT: The copy procedure is canceled, and you are returned to the Playback Setting Screen.



<Example: Sequential shots playback mode>



4 Press the SET button.

- The image is copied.
 - Select “EXIT”, and press the SET button, or press the MODE button, to return to the Playback Setting Screen.
-

HINT

To select a different image (frame) in step 3...

- Press [◀] or [▶] on the arrow button.

CHANGING IMAGE SIZE

The size of a still image that has already been captured at a resolution of **640** or more can be changed to 640 x 480 pixels or 320 x 240 pixels. The resized image is saved as a separate image.

1 Display the still image whose size you wish to change.

2 Display the Playback Setting Screen (see page 39).



3 Select the edit photo icon , and press the SET button.

- The Edit Photo Screen appears.



4 Select the resize icon , and press the SET button.

- The Size Change Screen appears.



5 Press [▲] or [▼] on the arrow button to select the new image size.

[640]: The saved image will be 640 x 480 pixels.

[320]: The saved image will be 320 x 240 pixels.

[EXIT]: Return to the Edit Photo Screen.

6 Press the SET button.

- A screen confirming whether the size change is correct appears.
-

7 Select “YES”, and press the SET button.

- Size changing begins.
- When size changing is completed, you are returned to the Edit Photo Screen.



ADDING TEXT

You can enter characters for titles and the like on still images.

1 Display the still image to which you want to add text.

2 Display the Playback Setting Screen (see page 39).

3 Select the edit photo icon , and press the SET button.

- The Edit Photo Screen appears.
-

4 Select the add text icon , and press the SET button.

- You enter the setup screen for text entry.
- Press the arrow button to set the position for the first character.
- The character position can be changed again later in this procedure (see page 134).
- If the image has been rotated, it will be returned to its original orientation.

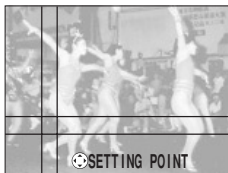

5 Press the SET button.

- You enter the text entry mode, and a row of characters appears.
- To return to the screen in step 4, press the MENU button.

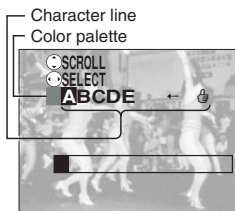

6 Press the arrow button to select the desired character row.

A B C D E	—	☺	, . , . • ?	—	☺
F G H I J	—	☺	! _ / ~ ()	—	☺
K L M N O	—	☺	「 」 + - × =	—	☺
P Q R S T	—	☺	< > " ¥ \$ %	—	☺
U V W X Y Z	—	☺	# & * @ ★ ●	—	☺
0 1 2 3 4	—	☺	▲ ▼ ※ → ← ↑	—	☺
5 6 7 8 9	—	☺	↓ ♪ ♥	—	☺

NOTE

- It is not possible to connect the camera to a TV to input the characters. Perform this procedure using the camera's LCD monitor.

ADDING TEXT

HINT

You can change the color of the text

- ① Before entering text, press [◀] to select the color palette located to the left of the characters on the character row.
- ② Press [▲] or [▼] to select the color for the text.
 - Press [▲] to cycle through the available colors as shown below.

White → Yellow → Orange → Red → Purple → Green → Blue → Navy blue → Gray → Black

Press [▼] to change colors in the reverse order.

- This completes the text color selection.
- Press [▶] and enter the desired text.
- By selecting the color palette and pressing the SET button, you can change the color of all the characters at one time.

7 Press [◀] or [▶] on the arrow button to select the character to enter.

[■]: Select this when you want to choose the color for a character (color palette).

(Blank space): Select this to enter a space. [■] appears in the character position.

[←]: Select this to move back one space (delete one character).

[⏏]: Select this when you have finished entering the desired text.

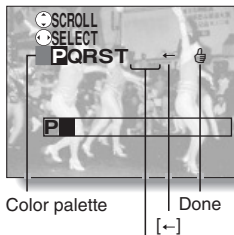

Select this area to type a space

8 Press the SET button.

- The selected character is entered on the text line.
- Repeat steps 6 to 8 to continue inputting characters. You can enter up to 12 characters, provided that the first character entered (in step 4) is set at the leftmost edge of the screen.

-
- 9** Select [] once you have entered all the desired characters, and press the SET button.

- This completes character entry.

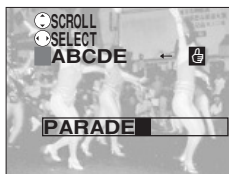

-
- 10** Press the arrow button to finalize the position of the text.

-
- 11** Press the shutter release button.

- The characters are superimposed on the image, and you are returned to the Edit Photo Screen.
- The image with text will be saved as the last still-image file.
- You can enter more characters on the same image as desired.



NOTE

- Once you have entered text onto an image, it is not possible to delete only the characters from that image.
- If the remaining number of images that can be captured is down to 0, then you may not be able to add text (see page 184).
- Text cannot be added to the following types of images:
 - Images captured using a preset setting of the scene select function
 - Images of resolution **320** or lower
 - Images captured using a different digital camera
 - Images saved after enlarging with the playback zoom (adding text may be possible depending on the resolution)

ADDING A VOICE MEMO

You can add a voice memo to a still image or sequential shots image previously recorded.

- 1 Display the still image or sequential shots image to which you will add the voice memo.
-

- 2 Display the Playback Setting Screen (see page 39).



<Example: Still Image playback mode>

- 3 Select the edit photo icon  (or ) , and press the SET button.
 - The Edit Photo Screen appears.



- 4 Select the add audio icon , and press the SET button.
 - You enter the setup screen to record a voice memo.



The  mark indicates that the image includes a voice memo.

5 Press the SET button.

- Voice memo recording starts. Talk into the microphone on the digital camera.
- The sound will be recorded for about 4 seconds.
- While the voice memo is being recorded, RECORDING and **REC** are displayed.
- When recording is finished, you are returned to the Edit Photo Screen.
- For images with a voice memo added, the volume icon  is shown on the Playback Setting Screen.

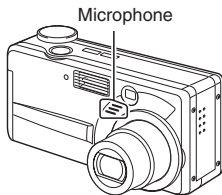

HINT

- For still images, you can also add a voice memo immediately after capturing an image (see page 104).
- After a voice memo has been added to an image, you cannot erase only the voice memo. When the image is erased, the attached voice memo is also erased.
- If a voice memo is added to an image that already has a voice memo, the new recording will replace the previous one.

COMBINING IMAGES (ADD PHOTO FUNCTION)

When capturing an image, you can superimpose (combine) it on an image already captured in the still image shooting mode, a saved magnified (zoom) image [page 97], or a copied image [page 128]. This is called the “add photo function.”

Use this function to perform simple image combining, such as adding a face photo to a name card photo.

Image combining procedure

Display the background image.



**Determine the size of
the superimposed image.**



**Determine the position of
the superimposed image.**



**Capture the superimposed image
(press the shutter release button).**

- The composite image is generated.
- The original image remains unchanged.

NOTE

- You cannot use the image combining function with the camera connected to a TV. Perform the procedure using the LCD monitor of the camera.

Before beginning the procedure to combine images, confirm the focus

When the subject of the composite image is close to the camera (10 to 50 cm), set the focus mode to  (macro photography, see page 72).

Display the background image

- 1** Display the image that you are going to use as the background.



- 2** Display the Playback Setting Screen (see page 39).

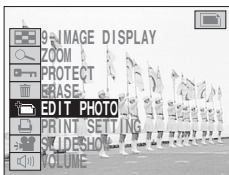

- 3** Select the edit photo icon , and press the SET button.
- The Edit Photo Screen appears.

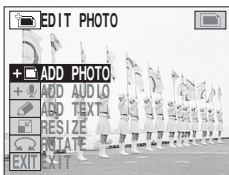

<Edit Photo Screen>

COMBINING IMAGES (ADD PHOTO FUNCTION)

- 4 Select the add photo icon , and press the SET button.

- Crosshairs (white lines) for setting the size of the superimposed image appear.
- If the image was rotated, it will be returned to its original orientation.



Determine the size of the superimposed image

At this time the size of the superimposed photo (frame) is determined. The frame is created by specifying its upper left corner (start point) and lower right corner (end point). The position of the frame is determined after this.

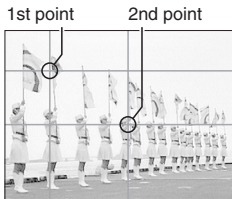

- 5 Press the arrow button to specify the start point.

[▲] and [▼] buttons:

Move the horizontal crosshair up and down.

[◀] and [▶] buttons:

Move the vertical crosshair left and right.

- If the arrow button is held down, the crosshair moves in continuous steps. Release the arrow button and the crosshair stops moving.

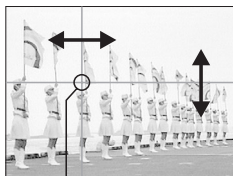

1st point

6 Press the SET button.

- The start point is fixed.
- The crosshairs for setting the end point appear.
- If you wish to reposition the start point, press the MENU button at this time.

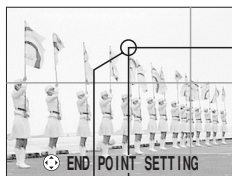

The start point is fixed here

7 Press the arrow button to specify the end point.

- When setting the end point, there is a position at which the crosshairs become green. This point marks the position at which the vertical-to-horizontal ratio of the frame is exactly 3:4.

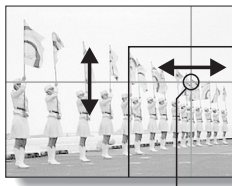

2nd point

8 Press the SET button.

- The size of the superimposed image is determined, and the area specified by the crosshairs now appears as a frame.
- If you wish to redo the frame, press the MENU button at this time.

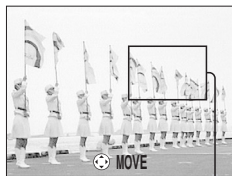

Frame

COMBINING IMAGES (ADD PHOTO FUNCTION)

Determine the position of the superimposed image

- 9** Press the arrow button to specify the position of the superimposed image (move the frame).
- Use the arrow button to move the frame to the position you wish the superimposed image to appear.
 - To delete the frame and start over, press the MENU button. You are returned to the screen for specifying the starting point (step 4).

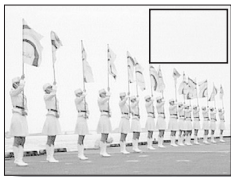

Capture the superimposed image

- 10** Press the SET button.
- The subject to photograph can be seen in the frame.
 - If the MENU button is pressed at this time, the frame is deleted, and you are returned to the screen in step 4.



Superimposed image

- 11** Compose the picture, and press the shutter release button.
- After the image is captured, you are returned to the Edit Photo Screen.
 - The composite image is completed and is added as the last file in the still image folder.
 - Press the MENU button or select the **EXIT** icon, and press the SET button; you are returned to the Playback Setting Screen.

CAUTION

- When capturing the superimposed image, the self-timer, flash, etc. cannot be used.
- The compression rate of the composite image becomes **NORM**. (The resolution does not change.)
- Image combining is not possible with the following types of images:
 - Images of resolution **320** or less
 - Images captured using a different digital camera
 - Images saved after being enlarged with the playback zoom (image combining may be possible depending on the resolution)

EDITING VIDEO CLIPS

You can cut a video clip at a desired point and save it from the beginning to that point as a separate video clip, or save from that point to the end as a separate video clip (“clipping”).

You can also join two video clips together and save them as one separate clip (“joining”).

Video clip clipping procedure

Display a video clip.



Decide whether to save the first part or the last part of the video clip.



Save the selected part as a new video clip (press the SET button).

- The cut video clip is saved.
- The original video clip remains unchanged. (You can also have it erased when the new video clip is saved.)



Video clip joining procedure

Display the video clip for the first part.



Select a second video clip to join to the first video clip.



Join the two video clips (press the SET button).

- Video clip joining is completed.



- The original video clips remain unchanged. (You can also have them erased when the new video clip is saved.)

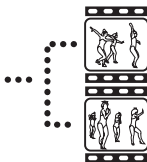

NOTE

Caution when editing video clips

- When editing video clips, do not move the main switch. If you move the main switch while editing video clips, not only will the editing not be properly completed, but the original video clip may also be erased.
- By repeating the clipping and joining procedures, you can create exactly the video clip you like. Note, however, that as the number or size of the video clips increases, the card memory may become full, making it impossible to edit the video clips. (The “MEMORY FULL” message will appear.) In this case, you will need to free some of the memory on the card either by deleting data that are no longer necessary [page 161], or by performing the procedure to erase the original video clip(s) [pages 147, 149].

EDITING VIDEO CLIPS

Saving part of a video clip (clipping)

1 Display the video clip you want to edit.

2 Display the scene you wish to cut.

- The selected scene will be included in the clipped portion, either as the last scene or the first.

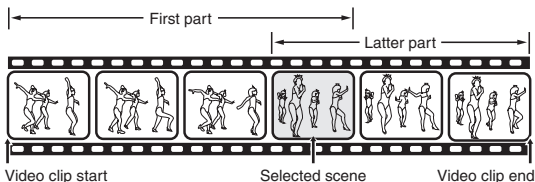

- To select the desired scene quickly, you can use a combination of the fast-forward (or reverse) playback, pause, and image-by-image playback functions (see page 90).

3 Display the Playback Setting Screen (see page 39).



4 Select the edit video icon , and press the SET button.

- The Edit Video Screen appears.
- The clipping icon  is selected.



<Edit Video Screen>

5 Press the SET button.

- The Clipping Screen appears.
- The clip former icon  is selected.



<Clipping Screen>

6 Press [▲] or [▼] on the arrow button to select the portion of the video clip you wish to save.

CLIP FORMER :

Saves the beginning part of the video clip (up to and including the selected scene).

CLIP LATTER :

Saves the ending part of the video clip (from and including the selected scene).

7 Press the SET button.

- A screen appears for you to confirm whether the selected scene is the correct cut point.
- To change to a different scene, press [◀] or [▶] on the arrow button.



EDITING VIDEO CLIPS

8 Press the SET button.

- A screen appears for you to confirm whether or not you want to erase the original video clip.

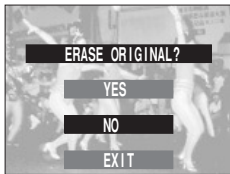

<Erase Original Video Clip Confirmation Screen>

9 Select whether you want the original video clip to be erased when clipping is executed.

YES : The original video clip is erased.

NO : The original video clip is not erased.

10 Press the SET button.

- "EDIT" appears, and then "LOADING" appears, after which you are returned to the Edit Video Screen.
- The selected portion of the video clip is saved as a separate video clip.
- If "YES" was selected in step 9, the original video clip is erased when the selected portion is saved.
- To return to the Playback Setting Screen, press the MENU button, or select the **EXIT** icon and press the SET button.



NOTE

- If the original video clip is protected, even if you select "YES" in step 9 and press the SET button, the original video clip will not be erased. If you want it to be erased, you will need to first remove the protection (see page 159).

Joining two video clips

- 1** Display the first video clip.

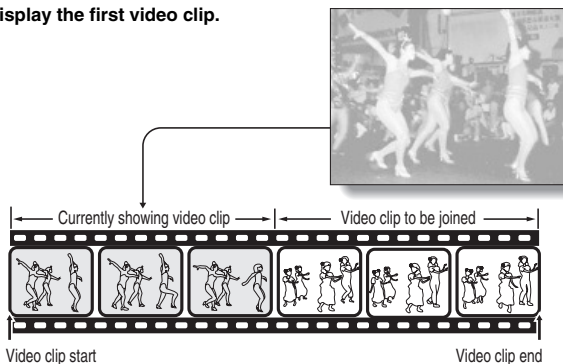

- 2** Display the Playback Setting Screen (see page 39).

- 3** Select the edit video icon , and press the SET button.

- The Edit Video Screen appears.



- 4** Press [▼] on the arrow button to select the joint icon .



EDITING VIDEO CLIPS

- 5** Press the **SET** button.
- The 9-image playback display for video clips appears.
-
- 6** Use the arrow button to move the orange frame to the video clip that you wish to join.
-
- 7** Press the **SET** button.
-

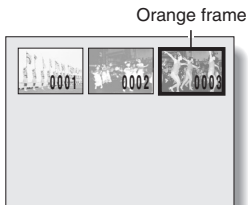

- 8** Select whether you want to have the original video clips erased when the joined video clip is saved.
- YES:** The original video clips are erased.
- NO:** The original video clips are not erased.



<Erase Original Video Clip Confirmation Screen>

9 Press the SET button.

- “EDIT” and then “LOADING” are displayed, after which you are returned to the Edit Video Screen.
- The two video clips are saved together as a separate video clip.
- If “YES” was selected in step 8, the original video clips are erased when the joined video clip is saved.
- Press the MENU button, or select the **EXIT** icon and press the SET button, to return to the Playback Setting Screen.



-
- If the original video clip is protected, even if you select “YES” in step 8 and press the SET button, the original video clip will not be erased. If you want it to be erased, you will need to first remove the protection (see page 159).

PRINT SETTINGS

In addition to using your printer to print out still images captured with your digital camera, as with conventional film, you can have prints made at shops offering digital print services. In addition, this digital camera is DPOF-compatible, so you can use the digital camera to specify the number of prints, whether or not the date is displayed on the print, and also to specify an index print.

1 Display the Playback Setting Screen (see page 39).



2 Select the print setting icon , and press the SET button.

- The Print Setting Screen appears.

STANDARD:

To print one image on one sheet (see page 153).

INDEX:

To print a small copy of all the images on one sheet for indexing purposes (see page 156).

ALL CLEAR:

To clear all the print settings (see page 157). This does not appear if no print settings have been made for the image.

EXIT:

To return to the Playback Setting Screen.

- To return to the Playback Setting Screen, press the MENU button, or select "EXIT" and press the SET button.



HINT

- To print out a still image from a sequential shots sequence or video clip at a digital print service shop, you must first copy the image and save it as a still image (see page 128).

About the DPOF format

- DPOF (Digital Print Order Format) is a print order format. It enables highly efficient printing from digital cameras and allows DPOF-compatible digital cameras to print out to DPOF-compatible printers.

PRINT SETTINGS

Standard print

Printing out one image on one sheet is called a “standard print.” With the standard print, you can specify how many copies you want to print out, as well as whether you want the date displayed on the print.

Specifying the date display on the prints.

- 1** Display the Print Setting Screen
(see page 151).
-

- 2** Select **STANDARD**, and press the **SET** button.

- The screen to select the date-set method appears.

ALL IMAGES:

The set print settings are applied to all the still images on the card.

EACH IMAGE:

The set print settings are applied only to the image currently displayed.

- 3** Press **[▲]** or **[▼]** on the arrow button to select the desired date-set method.



<Standard Print Screen>

4 Press the SET button.

- If EACH IMAGE was selected, press [◀] or [▶] on the arrow button to display the desired image to print.

SETTING: To set the standard print settings.

EXIT: To return to the Standard Print Screen.



5 Select "SETTING", and press the SET button.

- The Number/Date Print Screen appears.



<Number/Date Print Screen>

PRINT SETTINGS

6 Specify whether the date is displayed on the print, and the number of prints.

<Specifying dated prints>

- 1 Press [▲] or [▼] on the arrow button to select DATE.
- 2 Press [▶].
 - The Print Date Screen appears
- 3 Press [▲] or [▼] to select the desired option.

YES: To print the date.
NO: To not print the date.
- 4 Press the SET button.
 - You are returned to the Number/Date Print Screen.

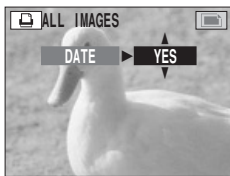

<Specifying the number of prints>

- 1 Press [▲] or [▼] on the arrow button to select NUMBER.
- 2 Press [▶].
 - The Print Number Screen appears.
- 3 Press [▲] or [▼] to specify the number of prints.
 - Press [▲] or [▼] until the desired number of prints is displayed.
- 4 Press the SET button.
 - You are returned to the Number/Date Print Screen.

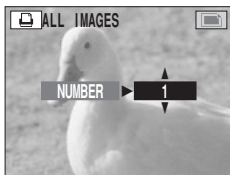

7 Select "EXIT" and press the SET button.

- The Standard Print Settings Completed Screen of step 4 appears.

Index print

Printing out many small images on one sheet is called an “index print.” This is convenient for use as a list of the images you have captured.

1 Display the Print Setting Screen (see page 151).

2 Select “INDEX”.

3 Press the SET button.

- The Index Print Screen appears.
- YES:** To specify an index print copy.
NO: To specify no index print copy.

4 Select “YES”, and press the SET button.

- This completes the setting for the index print. You are returned to the Print Setting Screen.



Changing the print settings

1 Follow steps 1 to 4 on pages 153 and 154.

2 Select “SETTING”, and press the SET button.

- The Number/Date Print Screen appears.
- Following the procedures in step 6 on page 155, use the arrow button to select the setting(s) you wish to change, and change the setting. The rest of the procedure is the same as step 7 on page 155.

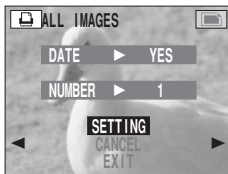

PRINT SETTINGS

Clearing the print settings

1 Display the Print Setting Screen (see page 151).

2 Select “ALL CLEAR”.

3 Press the SET button.

- The All Clear Screen appears.

YES: To clear the print settings for all images.

NO: To cancel the clear procedure and return to the Print Setting Screen.

4 Select “YES”, and press the SET button.

- All the print settings are cleared and you are returned to the Print Setting Screen.
- To return to the Playback Setting Screen, press the MENU button, and press the SET button.



HINT

- The current print settings for each image can be checked on the Information Screen.

Example: 2 standard prints with date display and an index print

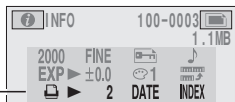

- Images that have been rotated will be printed in their original orientation.
- The quality of the print output will differ depending on the print service and printer used.

IMAGE PROTECT MODE (PREVENTING ACCIDENTAL ERASURE)

By using the image protect mode, you can prevent accidental erasure or overwriting of the important data that you wish to keep. The protect mode can be applied to a still image, to single images of a sequential shots sequence, to a video clip, or to an audio recording.

1 Display the data that you want to protect.

2 Display the Playback Setting Screen (see page 39).

3 Select the protect icon .

4 Press the SET button.

- “LOCK?” appears.
- If the protect mode has already been set for the data, then “UNLOCK?” appears.

5 Select “YES”, and press the SET button.

- The protect mode is set for the data.
- The protect mark  indicates that the data is locked.



<Example: Still Image Playback Mode>

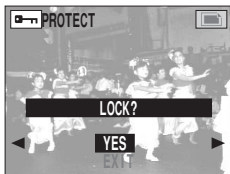

Protect mark

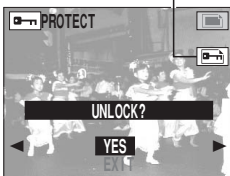

CAUTION

- Even if the protect mode is set for certain data files, they will be erased if the card is reformatted (see page 35).

HINT

To select a different image in steps 4 and 5...

- Press [◀] or [▶] on the arrow button.

To cancel the protect mode for an image...

- Select the desired data and repeat steps 2 to 5. The protect indicator will disappear and the protect mode is canceled.

ERASING DATA

You can erase data that is stored on the card if you no longer need it. You can erase the images, video clips, and sound recordings one at a time, or all at once.

1 Display the data that you want to erase.

2 Display the Playback Setting Screen (see page 39).

- To erase one image at a time or to erase one group at a time, instead of displaying the Playback Setting Screen, when you press the focus button, the screen in step 5 appears. In this case, follow the procedure from step 6.
-



<Example: Still Image Playback mode>

3 Select the erase mode icon .

4 Press the SET button.

- The Erase Mode Screen appears.

For still images:

ONE ERASE: Erases one still image at a time.

GROUP ERASE: Erases all the still images.

EXIT: Returns to the Playback Setting Screen.

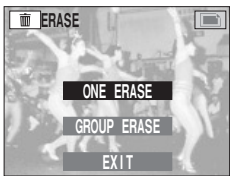

For sequential shots:

ONE ERASE: Erases the one still image displayed.

GROUP ERASE: Erases the entire folder for the sequential shots displayed (the data for other sequential shots remains).

EXIT: Returns to the Playback Setting Screen.

For video clips:

ONE ERASE: Erases the video clip displayed.

GROUP ERASE: Erases all the video clips.

EXIT: Returns to the Playback Setting Screen.

For audio recordings:

ONE ERASE: Erases one audio recording at a time.

GROUP ERASE: Erases all the audio recordings.

EXIT: Returns to the Playback Setting Screen.

-
- 5** Press **[▲]** or **[▼]** on the arrow button to select the desired type of erase, and press the **SET** button.

- The Erase Confirmation Screen appears.



<Example: Erase Single Image Confirmation Screen>

-
- 6** Press **[▲]**, and select "YES".

YES: Erases the selected data.

EXIT: Does not erase the selected data and returns to the Erase Mode Screen.

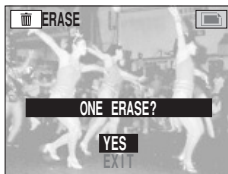

ERASING DATA

7 Press the SET button.

- “ERASING” is displayed, and the next image appears. The data is erased.
- To erase other data, press [◀] or [▶] to display the data that you want to erase and repeat steps 6 and 7.

HINT

To select a different data in step 5...

- If ONE ERASE is selected, press [◀] or [▶] on the arrow button to select different data.
- If “GROUP ERASE” is selected, all the images are erased, regardless of the image that is currently displayed.

HINT

To quickly erase the currently displayed image

- ① Display the image you wish to erase.
- ② Press the focus [] button.
 - The Erase Confirmation Screen appears.
- ③ Select “YES”, and press the SET button.
 - The displayed image is erased.

IMAGE AND AUDIO DATA STORAGE

Your captured images can be copied to the hard disk of a personal computer, or can be printed by a digital print service or with a printer. For copying to a personal computer, please refer to the instruction manual accompanying the provided CD-ROM (Sanyo Software Pack). For printing, use a digital print service or access a network print service.

Data file formats

The format of the files saved on the card and the method in which the file names are determined are explained below.

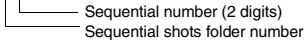
Type of data	Data format	File name structure
Still image data	JPEG or TIFF ⁽¹⁾	File name begins with SANY. Extension is ".jpg" or ".tif".
Voice memo data	WAVE	Same file name as corresponding still image or sequential shots data. Extension is ".wav". SANY****.wav
Sequential shots data	JPEG	File name begins with SEQT. Extension is ".jpg". SEQT****.jpg 
Video clip data	QuickTime Movie	File name begins with VCLP. Extension is ".mov". VCLP****.mov ⁽²⁾
Audio recording data	WAVE	File name begins with SUND. Extension is ".wav". SUND****.wav ⁽²⁾
Color adjustment settings data	cfg	File name begins with sancam. Extension is ".cfg" sancam**.cfg ** represents a number from 01 to 99.

*1: Design rule for Camera File system compliant

*2: Consecutive numbers assigned in the order the data was saved.

IMAGE AND AUDIO DATA STORAGE

Configuration of directories for the stored data

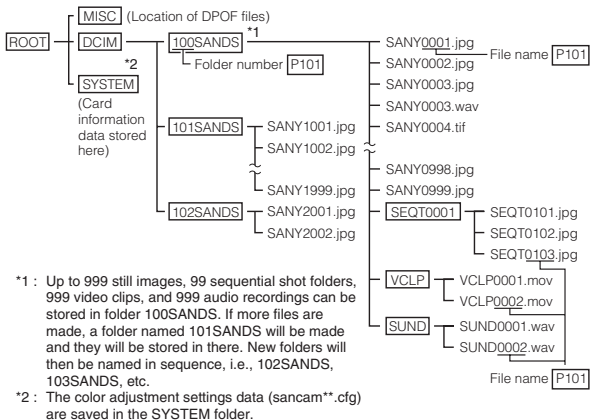

NOTE

Do not modify the folders and file names in the card using your computer

- If the folders, file names, or their configuration is modified using a personal computer, it will be impossible to play back the data using the digital camera, and the digital camera may not operate properly.

Concerning the video clip data saved by the digital camera

- You can use QuickTime Ver. 3.0 or later from Apple to play back the video clips.

QuickTime5 for Windows and Macintosh is supplied with the included CD-ROM (Sanyo Software Pack).

About file names when the card is replaced...

- If the file number reset function is set to off, even when the card is replaced, consecutive numbering of folder numbers and file names continues from the previously installed card (see page 180).

USING THE CAMERA WITH A COMPUTER

Using the camera as your computer's external drive

- 1 Turn off your digital camera (see page 38).
- 2 Using the supplied dedicated USB interface cable, connect the camera connector to the camera and the computer connector to the proper terminal on your computer.

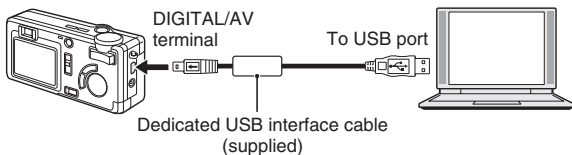

- Please connect the dedicated USB interface cable to your computer's USB connector. Do not connect it to the USB connector on your monitor or keyboard, or to the USB hub. Be especially careful when installing the driver software. In some instances, it may not be possible to correctly install the driver software.

USING THE CAMERA WITH A COMPUTER

3 Set the selector dial to [↔], and turn on the power.

- The camera changes to the PC connection mode.
- More information about these operations can be found in the instruction manual accompanying the included Sanyo Utility Software.

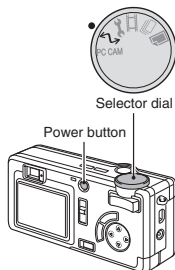

NOTE

- When your digital camera is connected to a computer, there is no display on the LCD monitor.

Using the camera as a PC camera

By connecting your digital camera to a personal computer, you can broadcast (remote photography, TV telephone, etc.) images taken with your camera over the Internet (PC camera function).

1 Connect the digital camera to a personal computer.

- The connection procedure is the same as step 1 and 2 on page 166.

2 Set the selector dial to [PCCAM].

- For the rest of the procedure, please refer to the instruction manual for the application software you are using for the PC camera.

CAUTION

- The PC camera function can be used only with computers in which Windows XP was preinstalled.
- The zoom cannot be used with the PC camera function. Moreover, only images can be recorded; audio data cannot be recorded.
- Although your camera can shoot at a maximum rate of 15 frames per second, the rate at which you can broadcast may be less than this depending on the speed of your Internet connection.

SETTING THE DATE AND TIME

The digital camera will record the date and time an image or audio recording is taken so that you can display them during playback. Therefore, before capturing images, make sure the correct date and time are set.

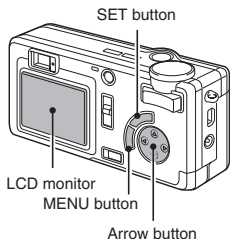

Example: To set the clock to September 28, 2002 at 7:30 p.m.

1 Display the Shooting or Playback Option Setting Screen (see page 39).

2 Select the clock set icon , and press the SET button.

- The CLOCK SET menu appears.
- The current date and time settings appear.
- Follow the procedures below to set whether to display the date during playback, to set the display format for the date, and to set the date and time.
- To return to the Option Setting Screen, press the MENU button, or select **EXIT** and press the SET button.

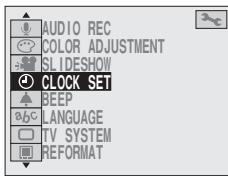

<Example: Shooting Option Setting Screen>

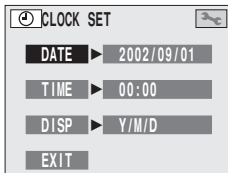

SETTING THE DATE AND TIME

3 Set the date.

- ① Press the arrow button to select [DATE].
- ② Press [▶].
 - The Set Date Screen appears.
- ③ Press the arrow button to set the date to “2002/9/28”.
 - Year setting → [▶] → Month setting → [▶] → Day setting.
 - Press [▲] to increase the number.
 - Press [▼] to decrease the number.
- ④ Press the SET button.

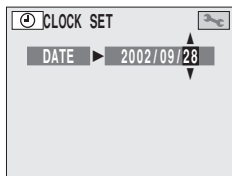

4 Set the clock.

- ① Press the arrow button to select [TIME].
- ② Press [▶].
 - The Set Time Screen appears.
- ③ Press the arrow button to set the time to “19:30”.
 - Hour setting → [▶] → Minute setting.
 - A 24-hour clock is used for the time display.
- ④ Press the SET button.

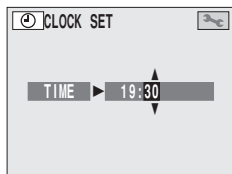

5 Set the order in which the date is displayed during playback.

- ① Press the arrow button to select [DISP].
- ② Press [▶].
 - The Set Date Format Screen appears.
- ③ Press [▲] or [▼].
 - When [▼] is pressed, the displayed date order changes as follows:

→ Year/month/day → month/day/year → day/month/year → DISP OFF (no display)

Press [▲] to change in the reverse order.

- If "DISP OFF" is selected, the date the image was captured is not shown during playback.
- ④ Press the SET button.

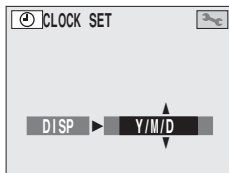

6 Select [EXIT], and press the SET button.

- The date and time setting is completed, and you are returned to the Option Setting screen.

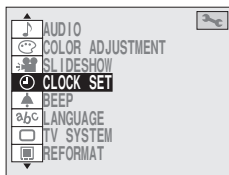

SETTING THE DATE AND TIME

NOTE

- If the date and time are not set, September 1, 2002 midnight is recorded as the date and time. Consequently, “2002/09/01 00:00” appears during playback.
- Under normal conditions, while the battery pack is being replaced, an internal battery will maintain the date and time settings. However, there is a small chance the settings may be lost. (The backup will last for approx. 7 days.) It is recommended to check that the date and time settings are still correct after replacing the battery pack and before shooting or recording of any type (follow steps 1 and 2).

To correct the date and time settings.

- After steps 1 and 2, press [▼] on the arrow button to select the line of the setting that you want to change, and press [▶] to select that setting. Then press [▲] or [▼] to set the new setting.

SETTING THE OPERATIONAL SOUNDS

This setting allows you to set whether or not a confirming audio signal sounds when the shutter release button, SET button, or MENU button is pressed.

Display the Operational Sounds Screen

1 Display the Shooting or Playback Option Setting Screen (see page 39).

2 Select the **BEEP** icon , and press the **SET** button.

- The Set Operational Sounds Screen appears.

BEEP: To set the operational sounds.

MUTE: To mute the operational sounds.

EXIT: To return to the Shooting or Playback Option Screen.

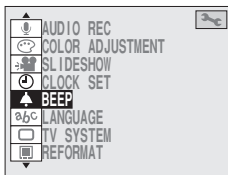

Setting the operational sounds

Set the operational sounds and actions.

1 Display the Operational Sounds Screen.

SETTING THE OPERATIONAL SOUNDS

2 Select “BEEP”, and press the SET button.

- The Operational Sounds Screen appears.

TURN ON/OFF:

Select the sound that is produced when the power is turned on or off.

SHUTTER:

Select the sound that is produced when the shutter release button is pressed.

KEY SW:

Select the operation sound that is produced when the SET button, MENU button, etc. is pressed.

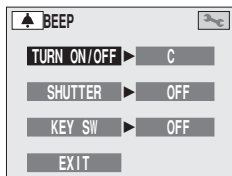

3 Press [▲] or [▼] on the arrow button to select the desired option, and then press [▶].

- The Select Operational Sound Screen appears.

4 Press [▲] or [▼] on the arrow button to select the desired operational sound.

- Select from 8 different sounds (A to H).
- You can hear the selected operational sound by pressing the shutter release button.
- If OFF is selected, no sound is produced.

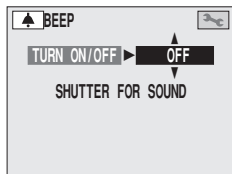

<Example: Select Turn On/Off Operational Sounds Screen>

5 Press the SET button.

- The operational sound is set, and you are returned to the Set Operational Sounds Screen.

Turning the operational sounds on/off

1 Display the Operational Sounds Screen.

2 Select “MUTE”, and press the SET button.

- The Set Mute Screen appears.
- ON:** The operational sounds are not produced.
- OFF:** The operational sounds are produced.
-

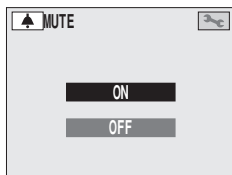

3 Select “ON” or “OFF”, and press the SET button.

- The operational sounds on/off is set, and you are returned to the Operational Sounds Screen.
-

HINT

- The volume of the operational sounds cannot be adjusted.

HELP FUNCTION

You can set whether or not the help display for the Shooting Setting Screen is shown.

1 Display the Shooting or Playback Setting Option Screen (see page 39).

2 Select the help display icon , and press the SET button.

- The Set Help Display Screen appears.

ON: The help display is shown.

OFF: The help display is not shown.

3 Select the desired setting, and press the SET button.

- This completes the help display setting.

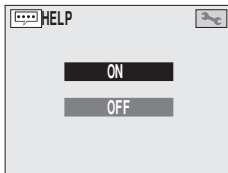
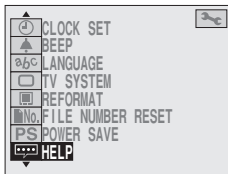

DISPLAY LANGUAGE

You can set the LCD monitor of your digital camera to display messages in either Japanese or English.

- 1** Display the Shooting or Playback Option Setting Screen (see page 39).

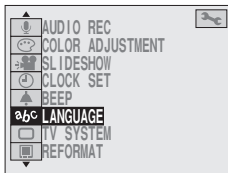

- 2** Select the language icon , and press the SET button.

- The Language Screen appears.

日本語 : Select for Japanese display.

ENGLISH: Select for English display.



- 3** Select the desired language, and press the SET button.

- The display language setting is completed.

POWER SAVE MODE

Your camera has a “power save” function whereby the power automatically turns off after a specified period of inactivity. The power save function works to conserve the battery pack power when the camera is not being used, or to prevent the battery pack from dying if the camera has accidentally been left on. You can specify the elapsed time (standby time) before the power save function is activated.

1 Display the Shooting or Playback Option Setting Screen (see page 39).

2 Select the power save icon [PS], and press the SET button.

- The Set Power Save Screen appears.

BATT/CAM:

Set the standby time for the shooting modes when the battery pack is used.

BATT/PB:

Set the standby time for the playback modes when the battery pack is used.

EXT.PWR/CAM.PB:

Set the standby time for the shooting and playback modes when the AC adapter is connected.

EXIT: Return to the Shooting or Playback Option Setting Screen.

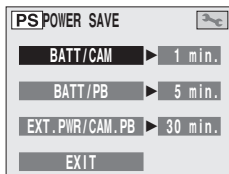
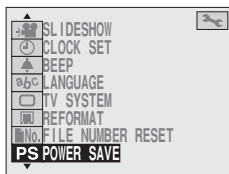

3 Press [▲] or [▼] on the arrow button to select the desired option.

4 Press [▶] on the arrow button.

- The Set Standby Time Screen appears.
-

5 Press [▲] or [▼] on the arrow button to set the standby time.

[▲]: Increases the standby time.

[▼]: Decreases the standby time.

6 Press the SET button.

- The standby time is set, and you are returned to the Set Power Save Screen.

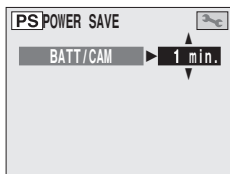

<Example: When "BATT/CAM" is selected>

SETTING THE TV SYSTEM

This setting is to specify the type of image signal that is output from the camera's DIGITAL/AV terminal.

- 1 Display the Shooting or Playback Option Setting Screen (see page 39).**
-

- 2 Select the TV system icon , and press the SET button.**

- The TV System Setting Screen appears.

NTSC: To output NTSC video signals

PAL: To output PAL video signals

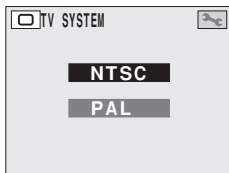
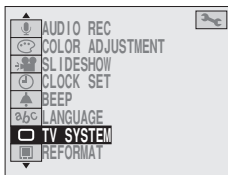

- 3 Select the appropriate TV system, and press the SET button.**

- The display returns to the screen shown in step 1.
-

CAUTION

- If the TV system setting is not correct for the connected TV, you will not be able to view the images on the TV.

ASSIGNING FILE NAMES

If a reformatted card is used, the file name (image number) of the captured image automatically begins from 0001. If the card is subsequently reformatted, or if a different reformatted card is used, the file names again begin from 0001. This is because the file number reset function is set to ON, and consequently it results in more than one card containing images with the same numbers. By setting the file number reset function to OFF, even if the card is reformatted or the card is replaced with another card, the consecutive numbering of file names continues from the last number recorded by the camera.

<File number reset function ON>



<File number reset function OFF>

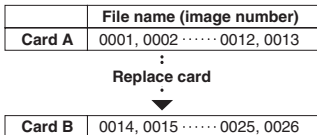

- If Card B already has image data in it when it replaces Card A, file names are assigned as follows.
- When the highest image number on Card B (before replacing) is lower than the highest image number on Card A: the file name of the next recorded image continues from last file name recorded on Card A.

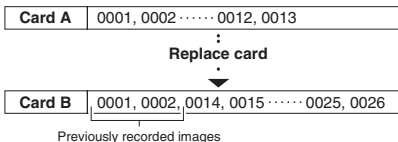

ASSIGNING FILE NAMES

- When the highest image number on Card B (before replacing) is higher than the highest image number on Card A: the file name of the next recorded image continues from last file name recorded on Card B.



1 Display the Shooting or Playback Option Screen (see page 39).

2 Select the file number reset icon .

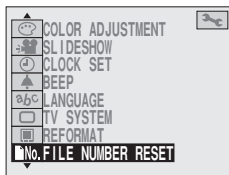

3 Press the SET button.

- The File Number Reset Screen appears.
 - ON:** The file number reset function is on.
 - OFF:** The file number reset function is off.

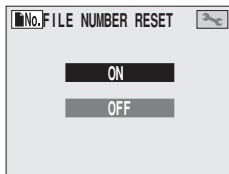

4 Select "OFF", and press the SET button.

- The file number reset function is deactivated.



NOTE

- Until the file number reset function is turned ON, consecutive file names are assigned. It is recommended that the file number reset function be returned to ON at the end of each photography session.





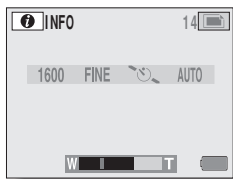

CHECKING THE REMAINING BATTERY PACK CHARGE

When using the battery pack, the remaining battery pack charge can be checked on the LCD monitor. Make sure to check this indicator before capturing an image. For an indication of the possible length of time for battery pack operation, see page 208.

1 Display a Shooting or Playback Information Screen (see pages 101, 126).

- The battery pack remaining charge indicator appears in the lower right corner of the LCD monitor.
-  and  (flashing) will appear even when the Shooting Information Screen or Playback Information Screen is not displayed.
- Due to the battery pack characteristics, when the ambient temperature is low,  may appear early for an incorrect indication of the remaining charge. Also, depending on the conditions of use of the digital camera or the ambient conditions (temperature, etc.), the indicated remaining charge may change. Therefore, this indication can only be used as a general approximation of the remaining charge.



Battery pack remaining charge indicator		Battery pack remaining charge
Information Screen	When Information Screen is not displayed	
	No indication	Approx. full.
	No indication	Power is low.
		It will soon be impossible to capture or play back images.
		If this icon flashes when the shutter release button is pressed, images cannot be captured. If it flashes while a video clip is being edited, the editing cannot be performed. Recharge the battery pack.

CHECKING THE REMAINING BATTERY PACK CHARGE

HINT

- If any data is present, you can also check the remaining battery pack charge on the Playback Information Screen.
- Use only the supplied or separately sold battery pack in this camera.
- Battery life may differ even among battery packs of the same type.
- Depending on the usage of the digital camera (such as the number of times the flash is used, the use of the LCD monitor, etc.) or the environmental conditions (temperature, etc.) the number of images that can be saved on a fully charged battery pack will vary greatly.



NOTE

- It is recommended that you prepare an extra battery pack(s) when taking pictures at a wedding or while traveling, for example, so you don't miss capturing images of important moments due to the battery pack power running out. The same is recommended for taking photos in cold environments. (In a ski area, for example, the battery pack can be kept warm in your pocket until ready to use.)

CHECKING THE REMAINING CARD MEMORY

You can check how many images can be captured and how much recording time is available on the card. For a table showing the maximum number of images and recording time for specific cards, please see “Possible No. of Images/Possible Shooting Time/Possible Recording Time” on page 209.

Checking the remaining number of images and video recording time

- 1 Set the main switch to [], and press the power button.
 - Set the selector dial to anything other than [] or [].
 - The remaining number of images appears in the upper right of the LCD monitor (for the still image and sequential shots shooting modes).
 - The remaining video recording time appears in the upper right of the LCD monitor (for the video clip shooting mode).
 - The remaining number of images and video recording time will differ depending on the resolution and compression settings.
 - When the remaining number of images or the remaining time of video clips that can be taken is “0”, you cannot capture any more images. To capture more images, either install a new card, or save the current images (see page 164) and then erase them (see page 161) from the card.

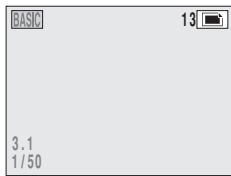
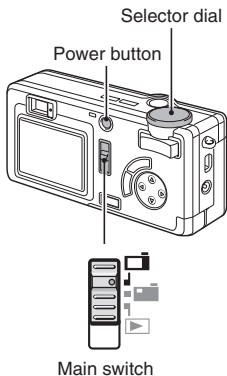

<Still image shooting mode>

CHECKING THE REMAINING CARD MEMORY

- When the remaining number of images or the remaining time of video clips that can be taken is “0”, it may be possible to capture a few more images by changing the shooting mode, setting a lower resolution setting (see page 79), or selecting a different compression setting (see page 82).

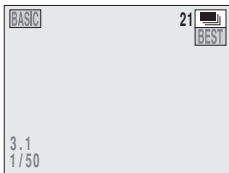

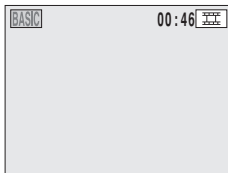

<Sequential shots shooting mode>



<Video clip shooting mode>

Checking the remaining audio recording time

1 Display the Shooting Option Setting Screen (see page 39).

- Set the selector dial to [].
- The audio recording icon  is highlighted.

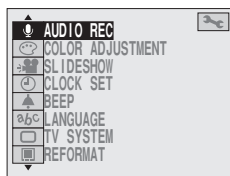

2 Press the SET button.

- The Audio Recording Screen appears, and the remaining recording time appears in the upper right of the LCD monitor.

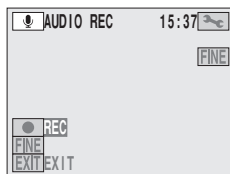

TROUBLESHOOTING

	Problem	Cause	Action	Reference page
Power	No power.	The battery pack is dead.	Change or recharge the battery pack.	31, 33
		The battery pack has not been inserted correctly.	Reinsert the battery pack, making sure to orient it correctly.	
		The battery compartment cover is not fully closed.	Close battery compartment cover properly.	
		Due to cold temperatures, the battery pack temporarily lost its power.	Place the digital camera in your pocket to warm it up before using it.	—
	The digital camera turns off by itself.	The power save function is operating.	Press the MENU button, or press the power button or shutter release button once.	38
	The battery pack is consumed very quickly even after it was fully recharged.	The ambient temperature is very low.	Keep the battery pack in an environment of 10 to 40°C.	—
Recharging does not end.	The battery pack life has expired.	Replace with a new battery pack. If this is not effective, consult your dealer.	—	

	Problem	Cause	Action	Reference page
Power	In the best select shot mode, the power turns off during operation.	The power save function is operating.	Not a malfunction. The 4 captured images are automatically saved in a sequential shots folder.	68
	The "NO BATTERY" message appears.	The remaining battery pack power is low.	Use a separately sold AC adapter (model VAR-G6EX for the VPC-MZ3EX/ VPC-MZ3GX, model VAR-G6E for the VPC-MZ3EX [for U.K.] and model VAR-G6U for the VPC-MZ3/ VPC-MZ3GX), or replace the battery pack with fully charged ones.	—
	While the flash is recharging, the LCD monitor suddenly turns off.	Battery pack power is low, activating the function that momentarily turns off the LCD monitor.	Not a malfunction. When the flash is fully charged, the LCD monitor will turn on again.	—

TROUBLESHOOTING

	Problem	Cause	Action	Reference page
Shooting	An image is not captured when the shutter release button is pressed.	The power is not turned on.	If the power save function has turned the digital camera off, then press the MENU button, or press once on the shutter release button to turn the digital camera back on.	37, 38
		The standby indicator is flashing red (the digital camera is not yet ready to capture an image).	Wait until the standby indicator lights green to capture the image.	—
		The memory is full (the standby indicator lights red, the displayed remaining number of images that can be captured becomes [0] on the LCD monitor).	Install a new card.	28
			Erase the images that are not necessary. Save the images to separate media, then erase all the images from the card.	161, 164

	Problem	Cause	Action	Reference page
Shooting	Accessing indicator lights red.	Recorded data is being saved on the card.	Not a malfunction. Wait until the accessing indicator turns off and the standby indicator lights green to capture the image.	—
	The flash does not operate.	The flash off mode is selected.	Set the flash to automatic flash mode or forced flash mode.	73
		The shooting mode is set to a mode other than the still image shooting mode.	Set the camera to the still image shooting mode.	59
		The digital camera has determined that the image is bright enough and the flash is not necessary.	Not a malfunction. Capture the image; the digital camera will determine when the flash is necessary.	—
		The battery pack is dead.	Change or recharge the battery pack.	28, 33
	The flash cannot be enabled.	The wide-range shot is set to on.	Set the wide-range shot to off.	103

TROUBLESHOOTING

	Problem	Cause	Action	Reference page
Shooting	AE shift sequential shots cannot be selected.	The exposure setting is set to manual [M] .	Set the exposure to a setting other than manual.	110
	The exposure of captured images in the AE shift sequential shots did not change.	The exposure may not change due to the surrounding brightness.	This is not a malfunction.	—
	During macro photography, the captured image is displaced from the image as seen through the viewfinder.	Due to the displacement between the camera lens and the viewfinder, a subject viewed close up through the viewfinder will appear lower in the captured image.	Compose the photo while viewing the LCD monitor.	—
	Self-timer photography is not possible.	The camera is set to a mode other than the still image shooting mode.	Set the camera to the still image shooting mode.	59
	A warning tone (beep-beep-beep) sounds, and it is not possible to take a picture using the self-timer.	The battery pack is consumed.	Install a sufficiently recharged battery pack.	28, 33





	Problem	Cause	Action	Reference page
Shooting	The digital zoom cannot be used.	The resolution is set the [1600] or higher.	Set the resolution to [640] or lower.	79
		The wide-range shot is set to on.	Set the wide-range shot setting to off.	103
	The add voice memo setting turned off.	An image was captured with a voice memo added.	Set the add voice memo function to ON again.	104
	During video clip shooting, the zoom movement stops momentarily.	The camera is switching from the optical zoom to the digital zoom.	Not a malfunction.	76
	During video clip shooting, the remaining recording time appears on the display, despite sufficient memory available in the card.	The speed at which data is saved to the card is slow.	Not a malfunction. This occurs when the captured image data is more than the data being saved to the card.	26
	A voice memo cannot be added.	The camera is set to a mode other than the still image shooting mode.	Set the camera to the still image shooting mode.	59

TROUBLESHOOTING

	Problem	Cause	Action	Reference page
Shooting	The exposure correction bar cannot be accessed.	The exposure control setting is set to manual [M] .	Set the exposure control to a setting other than manual.	110
		The sequential shots mode is set to AE shift [AE] .	Exposure correction is not possible for AE shift sequential shots. Not a malfunction.	—
	The Quick Shot setting cannot be accessed.	The resolution is set to [2000] .	Set the resolution to [1600] or lower.	79
		The compression rate is set to [TIFF] .	Set the compression rate to [FINE] , [FINE] or [NORM] .	82
		The wide-range shot setting is on.	Set the wide-range shot setting to off.	103
		The main switch is set to [] .	Set the main switch to [] .	37
	The exposure control menu cannot be selected.	The exposure control setting is fixed at [P] in the following cases: <ul style="list-style-type: none"> When the wide-range shot setting is on 	Not a malfunction.	—

	Problem	Cause	Action	Reference page
Shooting	There is noise in the captured image.	The shutter speed is too slow.	Set the shutter speed to a faster speed.	110
		The ISO sensitivity setting is too high.	Set the ISO sensitivity to a lower setting.	109
	Only the [ISO-A] ISO sensitivity setting can be selected.	The ISO sensitivity setting is fixed at [ISO-A] in the following cases: <ul style="list-style-type: none"> • When the exposure control is set to shutter speed priority AE [S] • When the flicker-reduction setting is on. 	Not a malfunction.	—
	[M] cannot be selected from the exposure control menu.	The sequential shots mode is set to [AE] .		
	The motion alert icon  is shown on the LCD display.	The shutter speed is slow.	Stabilize the camera with a tripod or the like.	81
Set the exposure control setting to [P] .			110	

TROUBLESHOOTING

	Problem	Cause	Action	Reference page
LCD monitor	When used in cold weather, the image may seem to leave traces as it moves.	Condition due to the liquid crystals.	Not a malfunction. Spots that appear in the LCD monitor only appear in the monitor and will not be recorded with the images.	—
	The image displayed contains some red, blue and green dots, or there are black spots visible.			
	The area around the LCD monitor is warm.	This is due to the internal structure and is normal.	Not a malfunction.	
	When capturing an image, no image is displayed on the LCD monitor.	The main switch is set to  .	Set the main switch to  .	37
	No playback image appears.	The main switch is not set to  .	Set the main switch to  .	37

	Problem	Cause	Action	Reference page
Viewing images	The focus does not work.	The subject is too close to the digital camera.	The distance for macro photography (focus set to ) is 10 to 50 cm. The distance for standard photography is 50 cm or more.	72
		The focus is not set properly.		
		The digital camera moved when the shutter was released.	Hold the digital camera correctly and slowly press the shutter release button halfway to lock the focus. Then press the shutter release button all the way to capture the image.	55, 60
		The focus is not locked properly.		
		The focus is not locked properly.	When using a slow shutter setting, use a tripod to stabilize the digital camera.	—
		The lens is dirty.	Clean the lens.	20

TROUBLESHOOTING

	Problem	Cause	Action	Reference page
Viewing images	The image is too dark.	The flash was blocked by a finger or other object.	Hold the digital camera correctly, and make sure the flash is not obstructed.	55
		The subject was too far away.	Capture the image in the range of operation of the flash.	75
		The subject was lit from behind.	Use the forced flash mode.	73
			Use the exposure correction function.	124
		There is not enough light.	Adjust the shutter speed.	110
			Adjust the ISO sensitivity setting.	109
	The image is too bright.	The forced flash mode is selected.	Select a different flash mode.	73
		The subject was too bright.	Change the angle of the digital camera.	—
			Use the exposure correction function.	124

	Problem	Cause	Action	Reference page
Viewing images	The image is too bright.	The ISO sensitivity setting is incorrect.	Set the ISO sensitivity to [ISO-A].	109
	The colors of the images captured indoors are not correct.	This is due to ambient lighting.	Capture the image using the forced flash mode.	73
		The white balance setting is incorrect.	Set the white balance setting correctly.	107
	The video clip picture is flickering.	The video clip was filmed under fluorescent lighting.	Set the flicker reduction setting.	125
	A part of the image is missing.	The handstrap or a finger was blocking the lens.	Hold the digital camera correctly, and make sure the lens is not obstructed.	55
		The image was captured at close range.	When capturing an image at close range, use the close-up alignment correction marks or compose the image using the LCD monitor.	—

TROUBLESHOOTING

	Problem	Cause	Action	Reference page
Viewing images	No image (📷 is shown).	This may happen when trying to play back images stored on a card from a different digital camera.	Play back images stored on a card using this digital camera.	—
	Vertical stripes appear.	If a bright subject is shot in the video clip shooting mode, vertical stripes may appear on the LCD monitor or in the image.	Not a malfunction.	—
	During slideshow playback, the voice memo is not played back.	The display time for each image was set to 1 sec.	Set the display time to 4 sec. or more.	95
	The magnified image is not clear.	Due to the characteristics of the camera, magnified images appear less clear.	Not a malfunction.	—
	The captured image is not clear.	The image was captured using the digital zoom.	Not a malfunction.	—
	"NO IMAGE" or "NO AUDIO" is shown.	There is no recorded data for the selected playback mode.	Set to a different playback mode.	85

	Problem	Cause	Action	Reference page
Viewing images	No image appears on the LCD monitor.	The camera is connected to a computer.	No image appears on the LCD monitor while the camera is connected to a computer.	166
	During audio playback, there is no sound.	The volume setting on the digital camera is too low.	Select the volume icon  and adjust the volume.	87
		No voice memo was recorded with the image.	Select the add voice memo setting, and speak into the microphone.	135
	When using the Microdrive, excess noise was also recorded.	The drive noise for the Microdrive was also recorded.	Not a malfunction.	—
	A strange sound is heard during video clip playback.	The sound of the autofocus motor was recorded.		

TROUBLESHOOTING

	Problem	Cause	Action	Reference page
Connecting to television set	No image or sound.	The digital camera is not correctly connected to the TV.	Follow the instructions to make the connection correctly.	99
		The TV input is not set correctly.	Set the input on the TV to "VIDEO".	
		The TV system setting is not correct.	Set to the correct TV system.	179
	There is no sound.	The volume on the TV is set to the minimum.	Adjust the volume on the TV.	—
		The volume setting on the digital camera is too low.	Select the volume icon  and adjust the volume.	87
The edge of the image is cut off.	This is a characteristic of the TV.	Not a malfunction.	99	
Image editing	The "CANNOT RESIZE" message appears.	The resolution is 640 .	It is possible to resize to 320 .	129
		The resolution is 320 .	Resize is not possible. Select a resolution of 640 or higher.	
	The "SIZE ERROR" message appears.	You have attempted to join video clips having different resolutions.	Select video clips that have the same resolution.	—

	Problem	Cause	Action	Reference page
Misc.	A sound is heard when the main switch is moved or when the digital camera is turned on.	This is a normal phenomenon.	Not a malfunction.	—
	Noise is heard from a nearby TV or radio during battery recharging.	Electromagnetic waves are emitted from the battery charger.	Move the battery charger further away from the TV or radio when recharging batteries.	—
	The "NO CARD" message appears.	No card is inserted.	Turn off the power and insert a card.	28
	The "MEMORY FULL" message appears.	There is no more available memory on the card.	Erase unnecessary data. Use a card that has more memory available.	161

TROUBLESHOOTING

	Problem	Cause	Action	Reference page
Misc.	The "PROTECTED" message appears and the data cannot be erased.	You have attempted to erase data that is protected from accidental erasure.	Set the protect setting for the data to OFF.	159
	The [🔒] indication appears.	The camera temperature is too high.	Turn off the power as soon as possible.	24
	The digital camera cannot be operated.	A temporary internal circuitry problem may be the cause.	Remove the battery pack from the digital camera, wait a few minutes, then reinstall the battery pack and try again.	—

	Problem	Cause	Action	Reference page
Misc.	The "SYSTEM ERROR" message appears.	A problem has occurred within the digital camera or card.	<p>Check the following items</p> <p>① Remove the card and then install it again.</p> <p>② Remove the batteries and then install them again.</p> <p>③ Remove the battery pack, wait approx. 1 hour, and then install it again.</p> <p>④ Install a different card.</p> <p>If "SYSTEM ERROR" still appears after performing the above steps, then take the digital camera to the dealer for service.</p>	—

SPECIFICATIONS

Digital Camera

Type	CCD digital camera (recording and playback)
Recording system	Digital recording
Image file format	Still images: JPEG format, TIFF (no compression) format (DCF, DPOF and Exif Ver2.2 compliant) Note: Designed mainly by the Japan Electronics and Information Technology Industries Association (JEITA), DCF (Design rules for camera file system) is standard for digital still camera image files to provide interoperability between digital photography devices for the images stored on removable memory cards. However, it is not guaranteed that all devices will support the DCF standard. Video clips: QuickTime Movie (Photo-JPEG) Audio: WAVE (monaural)
Data storage media	CompactFlash (Type I/II) Microdrive
Camera effective number of pixels	Approx. 1,950,000 pixels
Image sensor	1/1.8-inch CCD Virtual number of pixels: Approx. 2,110,000 pixels, progressive scan, primary color filter
Recording resolution	2,000 x 1,496 pixels (still images only) 1,600 x 1,200 pixels (still images and sequential shots only) 640 x 480 pixels (still images, sequential shots, and video clips) 320 x 240 pixels (video clips only) 160 x 120 pixels (video clips only)

Video clip frame rate	640 x 480 pixels: 30 fps/15 fps 320 x 240 pixels: 30 fps/15 fps 160 x 120 pixels: 30 fps/15 fps	
Data compression	TIFF (no compression) (still image shooting only) SFINE (very low compression) (still image shooting only) FINE (low compression) NORM (moderate compression)	
White balance	Full-auto TTL, manual setting possible	
Lens	Optical 3x zoom lens	f=7.7mm-23.1mm (35mm film camera conversion) f=37mm-111mm Auto focus, 5 groups, 6 elements
Focus modes	Multi-section focus, spot focus	
Aperture	Open F=2.7 (Wide) to 4.9 (Tele) Minimum F=6.7 (Wide) to 11.8 (Tele)	
Exposure control type	Aperture and shutter programmable AE/shutter speed priority AE/aperture priority AE/manual exposure control Exposure correction available from the Shooting Setting Screen (0±1.8EV in 0.3EV steps)	
Light-measuring modes	Multi-section measuring, center-weighted measuring, spot measuring	
Range	50 cm to infinity (normal photography), 10 cm (wide), 40 cm (tele) to 50 cm (macro photography)	
Digital zoom	For shooting Resolution 640 : 1x to 2.5x Resolution 320 : 1x to 2.5x Resolution 160 : 1x to 5x For playback: 1x to 31x (varies with resolution)	

SPECIFICATIONS

Shutter		<p>Still image shooting mode: 16 to 1/2,500 sec. (Aperture and shutter speed programmable AE: 1/4 to 1/2,500 sec.) (Slow shutter: 16, 8, 4, 2, 1 sec.) (For shutter speed priority AE and manual exposure control: 16 to 1/2,500 sec.) (Flash: 1/30 to 1/2,500 sec.)</p> <p>Sequential shots shooting mode: 1/10 to 1/10,000 sec.</p> <p>Video clip shooting mode: 1/15 to 1/10,000 sec.</p>
Sensitivity		Auto (equivalent to ISO100 to 200), and equivalent to ISO100, ISO200, and ISO400 (set at shooting setting screen)
Viewfinder		Optical direct image zoom viewfinder
LCD monitor		1.5-inch low temperature polysilicon TFT color liquid crystal (frame coverage: Approx. 100% when dedicated AV connection cable is not connected)
LCD monitor pixels		Approx. 110,000 pixels
Flash working range		0.5m to 3.1m (normal shooting lens at Wide setting), 0.5m to 1.7m (normal shooting lens at Tele setting), 0.1m to 0.5m (macro shooting lens at Wide setting), 0.4m to 0.5m (macro shooting lens at Tele setting)
Flash modes		Auto-flash, forced flash, flash off, and red-eye reduction
Focus		TTL-type AF, manual focus, fixed focus
Self-timer		10-second delay
Time/date		Recorded with image data
Ambient environment	Temperature	0 to 40°C (operation), -20 to 60°C (storage)
	Humidity	30 to 90% (operating, no condensation) 10 to 90% (storage, no condensation)
Power supply	Battery pack	Lithium-ion battery pack (DB-L10) x 1
	AC adapter (sold separately)	Model VAR-G6EX for the VPC-MZ3EX/ VPC-MZ3GX, model VAR-G6E for the VPC-MZ3EX [for U.K.] and model VAR-G6U for the VPC-MZ3/VPC-MZ3GX

Dimensions (excluding protrusions)	99 (W) x 55 (H) x 32.5 (D) mm
Weight	Approx. 210 g (without battery pack and card)

Digital camera connectors

DIGITAL/AV (communication/sound and image output) terminal	Regrouped jack	
	Audio output	265 mVrms (−9 dBs), 12 kΩ or less, monaural
	Video output	1.0 Vp-p, 75 Ω unbalanced, sync negative, composite video, NTSC color TV system/PAL TV system switchable
	USB	USB 1.1
DC IN (external DC power input) terminal	DC 4.7 V (for exclusive use with separately sold AC adapter [model VAR-G6EX for the VPC-MZ3EX/VPC-MZ3GX, model VAR-G6E for the VPC-MZ3EX [for U.K.] and model VAR-G6U for the VPC-MZ3/VPC-MZ3GX])	

Battery pack operation

Shooting	950 images: LCD monitor off, images captured in 20-second intervals, and flash used 1 in 3 times
	310 images: LCD monitor on, images captured in 20-second intervals, and flash used 1 in 3 times
Playback	210 minutes: LCD monitor on, and continuous playback

- Until battery pack runs out when using the supplied 16MB CompactFlash card (A CompactFlash is not included with Model VPC-MZ3GX.) and battery pack (fully charged) at a 20°C ambient temperature.
- The time of operation may vary depending on the conditions of the battery pack and the conditions of use. Especially when used at temperatures below 10°C, the battery pack operation time is drastically reduced.

SPECIFICATIONS

Possible No. of Images/Possible Shooting Time/Possible Recording Time

The table shows the possible number of images, the possible shooting time, and the possible recording time when using the supplied 16MB CompactFlash card (A CompactFlash is not included with Model VPC-MZ3GX.) and a commercially available 1GB Microdrive card.

Shooting/ recording mode	Resolution setting	Compres- sion rate or sound quality setting	Frame rate setting	CompactFlash (16MB)		Microdrive (1GB)	
				One shooting	Total	One shooting	Total
Still image mode (no voice memo)	2000	FINE	—	—	14 images	—	913 images
		NORM	—	—	21 images	—	1,360 images
	1600	TIFF	—	—	2 images	—	184 images
		SFINE	—	—	14 images	—	913 images
		FINE	—	—	23 images	—	1,420 images
		NORM	—	—	36 images	—	2,190 images
640	FINE	—	—	140 images	—	6,570 images	
	NORM	—	—	231 images	—	10,950 images	
Still image mode (with voice memo)	2000	FINE	—	—	13 images	—	888 images
		NORM	—	—	20 images	—	1,310 images
	1600	TIFF	—	—	2 images	—	183 images
		SFINE	—	—	13 images	—	888 images
		FINE	—	—	21 images	—	1,360 images
		NORM	—	—	34 images	—	2,050 images
640	FINE	—	—	109 images	—	5,470 images	
	NORM	—	—	157 images	—	8,210 images	
Sequential shots mode	1600	FINE	—	8 images	23 images	8 images	1,420 images
		NORM	—	15 images	40 images	15 images	2,520 images
	640	FINE	—	50 images	140 images	50 images	6,570 images
		NORM	—	50 images	231 images	50 images	10,950 images

One shooting: Maximum no. of images, shooting time, recording time when shutter release button is pressed once

Total: The maximum no. of images, shooting time, recording time that can be stored

Shooting/ recording mode	Resolution setting	Compression rate or sound quality setting	Frame rate setting	CompactFlash (16MB)		Microdrive (1GB)	
				One shooting	Total	One shooting	Total
Video clip mode	640	NORM NORM	30f	10 sec.	10 sec.	12 min.	12 min.
			15f	21 sec.	21 sec.	24 min.	24 min.
	320	FINE FINE NORM NORM	30f	25 sec.	25 sec.	28 min.	28 min.
			15f	50 sec.	50 sec.	56 min.	56 min.
			30f	48 sec.	48 sec.	54 min.	54 min.
			15f	1 min.	1 min.	1 hr.	1 hr.
	160	NORM NORM	30f	34 sec.	34 sec.	45 min.	45 min.
			15f	1 min.	1 min.	1 hr.	1 hr.
			30f	29 sec.	29 sec.	39 min.	39 min.
Sound recording mode	—	FINE	—	16 min.	16 min.	12 hrs.	18 hrs.
			—	41 sec.	41 sec.	—	—
	—	NORM	—	33 min.	33 min.	12 hrs.	37 hrs.
			—	23 sec.	23 sec.	—	—

One shooting: Maximum no. of images, shooting time, recording time when shutter release button is pressed once

Total: The maximum no. of images, shooting time, recording time that can be stored

- Even with cards of the same capacity, the amount of data that can actually be stored may differ depending on the card brand, etc.
- The continuous shooting time for each video clip will differ depending, for example, on the card capacity, environmental conditions (temperature and shooting conditions, etc.).

Example: Using a Microdrive at an ambient temperature of 25°C, resolution [320], compression rate [FINE], and frame rate [30f], the continuous recording time will be about 20 minutes, due to the rising internal temperature. If the camera is used when the internal temperature is elevated, it is more likely for the  icon (warning indicator for elevated temperature) to appear, and the usable time of the camera to become shorter. (See “Cautions concerning high temperatures” on page 24.)

Cautions when using the Microdrive

- When using the Microdrive continuously, the card will become very hot. Be careful when touching the card for removal, etc.
- When using the Microdrive, it will take a few seconds after the digital camera is turned on before the card can be used. This time will increase when more data is stored on the card.
- It will take a great deal of time to download large amounts of data from the Microdrive to your computer.
- Microdrive cards require more power than CompactFlash cards. Therefore the possible battery pack operation time (see page 208) when using the Microdrive will be much less than that when using a CompactFlash card.
- Microdrive cards are easily damaged by vibrations. Be sure to read the cautions supplied with the Microdrive.

SPECIFICATIONS

Supplied battery pack charger

Part number	VAR-L10	
Power source	AC 100 to 240 V, 50/60 Hz, 13 VA, 0.09 A	
Rated output	DC 4.2V, 0.7A	
Compatible batteries	Supplied or separately sold Lithium-ion battery pack (DB-L10)	
Ambient environment	Temperature	0 to 40°C (recharge), -20 to 60°C (storage)
	Humidity	10 to 85% (no condensation)
Dimensions	46 (W) x 37.5 (H) x 86 (D) mm	
Weight (without power cord)	Approx. 75 g	
Power cord rated value	VPC-MZ3	AC 125 V, 7 A
	VPC-MZ3EX, GX	AC 250 V, 2.5 A

- When using the supplied battery pack charger abroad, the power cord may need to be replaced in accordance with local requirements. Please contact your local dealer for details.

Supplied Lithium-ion battery pack

Model number	DB-L10	
Voltage	3.7 V	
Capacity	1,090 mAh	
Ambient environment	Temperature	0 to 40°C (during use, recharged) -10 to 30°C (storage)
	Humidity	10 to 90% (no condensation)
Dimensions	31.9 (W) x 10 (H) x 45.8 (D) mm	
Weight	Approx. 35 g	

- Products are subject to change in design and specifications without notice and without incurring any obligation.

BASIC mode and EXPERT mode

The BASIC mode makes it easy for a person not familiar with digital camera operation to take photos, but having the camera automatically set the shooting functions and minimizing the number of functions you have to deal with. On the other hand, the EXPERT mode is perfect for the photographer who likes to have full control over all a camera's shooting functions and settings. The table below shows which shooting functions are controlled by the camera operator in each mode. Note that functions for which camera buttons are furnished, such as flash, zoom, focus modes, etc., are always available in both modes.

	Still image shooting mode		Sequential shots shooting mode		Video clip shooting mode	
	BASIC mode	EXPERT mode	BASIC mode	EXPERT mode	BASIC mode	EXPERT mode
Scene select setting	yes		yes		yes	
Sequential shots mode setting			yes	yes		
Resolution setting	yes	yes	yes	yes	yes	yes
Compression rate setting	yes	yes	yes	yes	yes	yes
Sequential shots interval setting			yes	yes		
Frame rate setting					yes	yes
Self-timer setting	yes	yes				
Wide-range shot setting		yes				
Voice memo setting		yes				
Spot focus setting		yes		yes		yes
Light-measuring mode setting		yes		yes		yes
White balance setting		yes		yes		yes
ISO sensitivity setting		yes		yes		yes
Exposure control setting		yes		yes		
Color correction setting		yes		yes		yes
Digital zoom setting		yes		yes		yes
Flicker-reduction setting						yes
Quick Shot setting		yes				
Exposure correction setting		yes		yes		yes

yes: Can be set

SPECIFICATIONS

Others

Microdrive and PowerPC are registered trademarks of International Business Machines Corporation.

Apple, Macintosh and QuickTime are trademarks or registered trademarks of Apple Computer Inc.

Windows and Windows NT are registered trademarks of Microsoft Corporation.

CompactFlash is a trademark of SanDisk Corporation and handed over to CFA (CompactFlash Association).

All other company and product names are registered trademarks or trademarks of their respective owners.

Caution

- It is forbidden to copy this manual, whole or in part, without prior written permission.
- All images and illustrations given in this manual are for explanation purposes and may differ slightly from that of the actual product. Also, actual specifications are subject to change without prior notice and therefore may differ from the contents of this manual.
- Sanyo Electric shall not be held responsible for any problems resulting from the use of this digital camera.
- Sanyo Electric declines all responsibility for damages due to improper use of the camera, failure to adhere to the instructions given in this manual, or repairs or changes done by those other than a technician authorized by the manufacturer.
- Sanyo Electric shall not be held responsible for any damage caused by optional devices or consumable items used with the digital camera other than those supplied with the digital camera or those specified by Sanyo Electric.
- Sanyo Electric shall not be held responsible for any losses or loss of revenue resulting from the loss of data caused by the malfunction, or the repairing of a malfunction, of the digital camera.
- The images captured with this camera will differ in quality from pictures taken with a standard film camera.

SANYO

SANYO Electric Co., Ltd.